

jardinico®

PRICELIST 2025

UMBRELLAS









packaging dimensions  
dimensions de l'emballage  
verpakkingsafmetingen



tilt in height  
inclinable en hauteur  
kantelen in de hoogte



tilt left - right  
inclinable à gauche et à droite  
kantelen naar links en rechts



360° rotation  
rotation de 360°  
360° rotatie



modular  
modulaire  
modulair



**Fast stock**  
uit voorraad leverbaar  
available on stock  
disponibles sur stock

MADE FOR **SHADE**

## CARACTÈRE

<b>JCP.1 SERIES</b>	JCP.102 - 230 x 230 cm	11
<b>JCP.2 SERIES</b>	JCP.201 - 400 x 400 cm	12
	JCP.202 - 500 x 500 cm	13
	JCP.203 - ø 450 cm	14
<b>JCP.3 SERIES</b> <small>UPDATED</small>	JCP.301 - 300 x 300 cm	15
	JCP.302 - 260 x 260 cm	16
	JCP.303 - ø 350 cm	17
<b>JCP.4 SERIES</b>	JCP.401 - 370 x 370 cm	18
	JCP.402 - 425 x 300 cm	19
	JCP.403 - ø 400 cm	20
	JCP.404 - 250 x 350 cm	21
<b>JCP.5 SERIES</b>	JCP.501 - 4 * 300 x 300 cm	22
<b>JCP.6 SERIES</b>	JCP.601 - 2 * 300 x 300 cm	23

## ATTITUDE

<b>AZORE</b>	300 x 300 cm	27
<b>ANTEGO</b>	300 x 200 cm	28
	300 x 300 cm	
	ø 350 cm	
<b>LIMA</b>	400 x 300 cm	30
	400 x 400 cm	
<b>TULI</b> <small>UPDATED</small>	150 x 210 cm	32
	200 x 200 cm	
	240 x 240 cm	
	ø 270 cm	
<b>AMALFI</b>	250 x 250 cm	34
	300 x 300 cm	
	ø 300 cm	
<b>MACRAMÉ</b> <small>NEW</small>	ø 250 cm	36
<b>CUBA</b>	300 x 300 cm	38
	ø 350 cm	
<b>MOOREA</b>	300 x 300 cm	40
<b>MORE PLUS - MEER</b>	Attitude bases - parasolvoeten	42
	Luna LED umbrella light	80



# DECORATION

## **DECORATION** **DECORATIE**

Pottery - Pots - Potten	53
Rugs - Tapis - Tapijten	70
Poufs - Poefs	72
Lighting - Éclairage - Verlichting	74
Accessories - Accessoires	76
Deco cushions Coussins de décoration Decokussens	77
Protection & maintenance - onderhoud & bescherming	78
Parasol accessories - parasol accessoires	80
Materials - matériaux - materialen	81
Wind scale - échelle du vent - windschaal	86

This price list includes recommended retail prices in EURO and replaces all previous versions.  
Valid from 01.10.2024.

## PAYMENT CONDITIONS

Available at [www.jardinico.com](http://www.jardinico.com) or contact our team for more information.

## AFTER-SALES SERVICE

Please address all complaints and questions about the after-sales service to [service@jardinico.com](mailto:service@jardinico.com).  
Please explain the problem and include as many photos as possible to prove it.  
Our team will contact you as soon as possible and help you further.

## WARRANTY

We provide, barring different agreement of more or less, a maximum warranty of 2 years on our products. The warranty takes effect on the day that the product is purchased from an official commercial partner of Jardinico® Parasols (date of invoicing). The warranty applies to production and/or materials errors, caused by normal use. The product shall not be replaced in its entirety if a defective part and/or component can be replaced. Jardinico® Parasols shall by no means be held to provide a warranty if the defects are the result of improper or incorrect use by the final user. Please consult the general terms and conditions on our website to learn more about the exceptions to the warranty.

The representation of colours, dimensions and weights may differ from reality, as may variations when a product is handmade. Prices, dimensions and technical details are subject to change without notice. Jardinico is not responsible for any printing and/or typing errors. Our general sales conditions always apply - see website.  
Jardinico® Parasols BV. All rights reserved.

## PRODUCT REFERENCES

Use our simplified, easy-to-use product references to place your order. Please include the correct codes for each order so that we can provide the best service and reduce the risk of errors.

- Product category (1): UF = umbrella frame, UC = umbrella canopy, UB = umbrella base, ...
- Product or product range (2): JCP.101, JCP.1S, ANT = Antego, KIN = Kingston, AMA = Amalfi, ...
- The product already implies the dimensions of the parasol for the Caractère collection.  
For the Attitude umbrella collection, the size needs to be mentioned (3): 300X300, 200X300, 350XR, ...
- Finishing and/or colour (4): A01 = aluminium white, C001 = canopy natural, S01 = steel white, ...

UFJCP.301-A01



UFANT300X300-A01



UCANT300X300-C001



- Catégorie de produit (1): FU = furniture, CU = cushion, DE = decoration, ...
- Collection (2): TUG = tugu, LEG = legna, SCO = scoop, ...
- Product (3): AC = armchair, 1S = sofa 1S, SL = sunlounger, ...
- Finition et/ou couleur (4): A01 = aluminium white, C008 = cushion linen, W62 = teak, ...

FUTUGAC05-F16



CUTUGAC05-C008

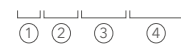

Ce tarif contient des prix de vente recommandés en EURO et remplace toutes les versions précédentes.  
Valable à la partir du 01.10.2024.

## CONDITIONS DE PAIEMENT

Disponible sur [www.jardinico.com](http://www.jardinico.com) ou contactez notre équipe pour plus d'informations.

## SERVICE APRÈS-VENTE

Veillez adresser toute réclamation et demande de service après-vente à [service@jardinico.com](mailto:service@jardinico.com).  
Veillez expliquer le problème et inclure autant de photos que possible pour le démontrer.  
Notre équipe vous assistera dans les plus brefs délais.

## GARANTIE

Nous accordons, sauf autre accord contraire supérieur ou inférieur, maximum 2 ans de garantie sur nos produits. La garantie prend effet le jour où le produit est acheté auprès d'un partenaire officiel de Jardinico® Parasols (date de facturation).  
Le garantie s'applique aux défauts de production et/ou aux défauts de matériau engendrés par un usage normal. Le produit ne sera pas entièrement remplacé si la pièce et/ou le composant défectueux peut être remplacé. Jardinico® Parasols n'offre dans aucun cas une garantie lorsque les défauts sont la conséquence d'un usage impropre ou abusif par l'utilisateur final.  
Veillez consulter les conditions générales sur notre site web pour en savoir plus sur les exceptions à la garantie.

La reproduction des couleurs, les mesures et les poids peuvent différer de la réalité ainsi que des variations chaque fois qu'un produit est fait à la main. Les prix, dimensions et détails techniques peuvent être sujets à changement sans préavis.  
Jardinico n'est pas responsable des erreurs d'impression et/ou de frappe. Nos conditions générales de vente sont toujours applicables - voir notre site web. Jardinico® Parasols BV. Tous les droits sont réservés.

## RÉFÉRENCES DE PRODUITS

Utilisez nos références de produits simplifiées et faciles à utiliser pour passer votre commande. Veuillez inclure les codes corrects avec chaque commande afin que nous puissions fournir le meilleur service et limiter les risques d'erreur.

- Catégorie de produit (1): UF = umbrella frame, UC = umbrella canopy, UB = umbrella base, ...
- Série de produits ou de produits (2): JCP.101, JCP.1S, ANT = Antego, KIN = Kingston, AMA = Amalfi, ...
- Le produit implique déjà les dimensions du parasol d'extérieur pour la collection Caractère.
- Pour la collection Attitude, il faut mentionner la taille (3) : 300X300, 200X300, 350XR, ...
- Finition et/ou couleur (4): A01 = aluminium white, C001 = canopy natural, S01 = steel white, ...

UFJCP.301-A01



UFANT300X300-A01

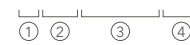

UCANT300X300-C001



- Catégorie de produit (1): FU = furniture, CU = cushion, DE = decoration, ...
- Collection (2): TUG = tugu, LEG = legna, SCO = scoop, ...
- Product (3): AC = armchair, 1S = sofa 1S, SL = sunlounger, ...
- Finition et/ou couleur (4): A01 = aluminium white, C008 = cushion linen, W62 = teak, ...

FUTUGAC05-F16



CUTUGAC05-C008





Deze prijslijst bevat aanbevolen verkoopprijzen in EURO, en vervangt alle eerdere versies.  
Geldig vanaf 01.10.2024.

## BETALINGSVOORWAARDEN

Beschikbaar op [www.jardinico.com](http://www.jardinico.com) of neem contact op met ons team voor meer informatie.

## DIENST NA VERKOOP

Gelieve alle klachten en vragen over de dienst na verkoop te richten aan [service@jardinico.com](mailto:service@jardinico.com).  
Leg het probleem uit en voeg zoveel mogelijk foto's toe om het probleem aan te tonen.  
Ons team zal zo spoedig mogelijk contact opnemen en verder helpen.

## GARANTIE

Wij verlenen, behoudens andersluidende overeenkomst in meer of in min, maximaal 2 jaar garantie op onze producten.  
De garantie start op de dag dat het product door een officiële handelspartner van JARDINICO Parasols is aangekocht (facturatedatum). De garantie is van toepassing op productie- en/of materiaalfouten, veroorzaakt ten gevolge van een normaal gebruik. Het product zal niet geheel vervangen worden als een defect onderdeel en/of component vervangen kan worden. JARDINICO Parasols zal geenszins tot garantie gehouden zijn wanneer de gebreken het gevolg zijn van een oneigenlijk of verkeerd gebruik door de eindgebruiker. Raadpleeg de algemene voorwaarden op onze website voor meer informatie over de uitzonderingen op de garantie.

De weergave van kleuren, afmetingen en gewichten kan afwijken van de werkelijkheid, evenals variaties wanneer een product handgemaakt is. Prijzen, afmetingen en technische details kunnen zonder voorafgaande kennisgeving worden gewijzigd. Jardinico is niet verantwoordelijk voor eventuele druk- en/of typfouten. Onze algemene verkoopvoorwaarden zijn altijd van toepassing - zie website. Jardinico® Parasols BV. Alle rechten voorbehouden

## PRODUCTREFERENTIES

Gebruik onze vereenvoudigde, gebruiksvriendelijke productreferenties om uw bestelling te plaatsen. Gelieve bij elke bestelling de juiste codes te vermelden zodat wij de beste service kunnen bieden en de kans op fouten beperken.

- Product categorie (1): UF = umbrella frame, UC = umbrella canopy, UB = umbrella base, ...
- Product of product series (2): JCP.101, JCP.1S, ANT = Antego, KIN = Kingston, AMA = Amalfi, ...
- Het product impliceert reeds de afmetingen van de parasol voor de Caractère collectie.  
Voor de Attitude parasol collectie dient de afmeting vermeld te worden (3): 300X300, 200X300, 350XR, ...
- Afwerking en/of kleur (4): A01 = aluminium white, C001 = canopy natural, S01 = steel white, ...

UFJCP.301-A01



UFANT300X300-A01

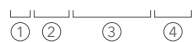

UCANT300X300-C001

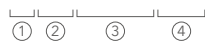

- Product categorie (1): FU = furniture, CU = cushion, DE = decoration, ...
- Collectie (2): TUG = tugu, LEG = legna, SCO = scoop, ...
- Product (3): AC = armchair, 1S = sofa 1S, SL = sunlounger, ...
- Afwerking en/of kleur (4): A01 = aluminium white, C008 = cushion linen, W62 = teak, ...

FUTUGAC05-F16



CUTUGAC05-C008







**OUTDOOR SHADE**  
CARACTÈRE COLLECTION





Center pole frame, powder coated aluminium.  
Mât central, aluminium thermolaqué.  
Middenstam parasol, gepoederlakt aluminium.

Tilt and rotation not applicable.  
Inclinaison non applicable.  
Kantelen en roteren niet van toepassing.







Powder coated hot galvanized steel base with 360° rotating wheels, each with a brake.  
Base en acier galvanisé à chaud thermolaqué avec roues pivotant 360°, chacune avec un frein.  
Gepoederlakte, warme verzinkte staalplaten voet met 360° draaiende wielen, elk met een rem.

# JCP.1 SERIES

base - voet 44 kg: max. 43 km/h, 26.7 mph  
base - voet 65 kg: max. 58 km/h, 36 mph

## JCP.102 - 230 X 230 CM

### UFJCP.102 FRAME - STRUCTURE

		Base - Voet 44 kg	Base - Voet 65 kg	IGB OGB
	A01 white	choose category of fabric	choose category of fabric	choose category of fabric
	A03 linen			
	A10 cappuccino			
	A12 alu teak			
	A31 charcoal			
	A32 black			

### UCJCP.102 CANOPY - TOILE - DOEK

#### CATEGORY 3

		€ 2.295	€ 2.795	€ 1.795
	C003 pearl			
	C011 cotton			
	C022 Nile <b>NEW</b>			
	C207 onyx			
	C210 pitch			
	C305 umber			

#### CATEGORY 2

	C019 tofu <b>NEW</b>	€ 2.095	€ 2.595	€ 1.595
	C023 heather <b>NEW</b>			

#### CATEGORY 3

see overview fabrics on p. 81 - minimum 8 umbrellas / colour	€ 2.295	€ 2.795	€ 1.795
--	---------	---------	---------

#### CATEGORY 2

see overview fabrics on p. 82	€ 2.095	€ 2.595	€ 1.595
-------------------------------	---------	---------	---------

### UBJCP.15-A BASE - PARASOLVOET 44 kg

		incl.	/	/
	S01 white			
	S03 linen			
	S31 charcoal			
	S32 black			

UBJCP.1565 base - parasolvoet 65 kg (same colours as base 44 kg)	/	incl.	/
--	---	-------	---

Has the same colour as its frame. An alu teak or cappuccino frame has a charcoal base.  
La même couleur que la structure. Un mât couleur alu teak ou cappuccino a une base charcoal.  
Heeft dezelfde kleur als het frame. Een frame in alu teak of cappuccino heeft een charcoal parasolvoet.

UBIGB-JCP.15 in ground base - ancre de sol - grondanker <b>OR/OU/OF</b>	/	/	incl.
UBOGB-JCP.15 on ground base - plaque de fixation - bevestigingsplaat			

### COVER - HOUSSE - HOES

	UPJCP.15-X77 black	incl.	incl.	incl.
---	--------------------	-------	-------	-------

	frame	base 44 kg	base 65 kg
nett weight	17 kg, 37.5 lbs	44 kg, 97 lbs	65 kg, 143 lbs
gross weight	20 kg, 44.1 lbs	49 kg, 108 lbs	70 kg, 154.3 lbs
	227 x 17 x 17 cm, 0.7 cbm	51 x 51 x 17 cm, 0.04 cbm	52 x 52 x 9 cm, 0.04 cbm

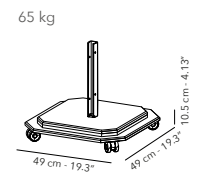
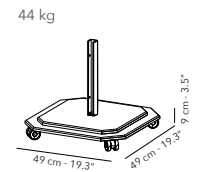

Push-up hub system

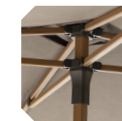

LOXX® system

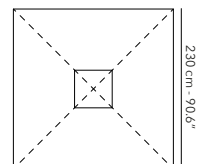
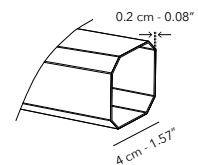
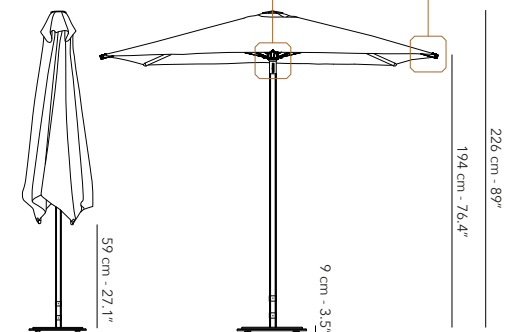

All dimensions exclude the base. - Toutes les dimensions excluent la base. - Alle afmetingen zijn exclusief de parasolvoet.

# JCP.2 SERIES

Center pole frame, powder coated aluminium.  
Mât central, aluminium thermolaqué.  
Middenstam parasol, gepoederlakt aluminium.



Tilt and rotation not applicable.  
Inclinaison non applicable.  
Kantelen en roteren niet van toepassing.

Powder coated hot galvanized steel base with 360° rotating wheels, each with a brake.  
Base en acier galvanisé à chaud thermolaqué avec roues pivotant 360°, chacune avec un frein.  
Gepoederlakte, warme verzinkte staalplaten voet met 360° draaiende wielen, elk met een rem.

max. 58 km/h, 36 mph



## JCP.201 - 400 X 400 CM

### UFJCP.201 FRAME - STRUCTURE

		Base Voet	IGB OGB
	A01 white		A31 charcoal
		choose category of fabric	choose category of fabric

### UCJCP.201 CANOPY - TOILE - DOEK

#### CATEGORY 3

		FAST STOCK	ON DEMAND
	C003 pearl		C011 cotton
	C022 Nile <b>NEW</b>		C207 onyx
	C210 pitch		C305 umber
		€ 5.995	€ 4.295

#### CATEGORY 2

	C019 tofu <b>NEW</b>		C023 heather <b>NEW</b>
		€ 5.595	€ 3.895

#### CATEGORY 3

see overview fabrics on p. 81 - minimum 3 umbrellas / colour	€ 5.995	€ 4.295
--	---------	---------

#### CATEGORY 2

see overview fabrics on p. 82	€ 5.595	€ 3.895
-------------------------------	---------	---------

### UBJCP.25-35-A BASE - PARASOLVOET

	S01 white		S31 charcoal	incl.	/
--	-----------	--	--------------	-------	---

UBIGB-JCP.25-35 in ground base - ancre de sol - grondanker **OR/OU/OF**

UBOGB-JCP.25-35 on ground base - plaque de fixation - bevestigingsplaat

UAJCP.25-35 in/on ground base plate cover - couvercle de la plaque - afdekplaat (same colours as base) **OPTIONAL**

/	incl.
/	€ 99

### COVER - HOUSSE - HOES

	UPJCP.25-X77 black	incl.	incl.
---	--------------------	-------	-------

### GUTTERS - GOUÏTIÈRES - GOTEN

UAJCP.25 colour of the canopy - couleur de la toile - kleur van het doek	€ 595 /pc.
--	------------



Telescopic hub system\*



LOXX® system

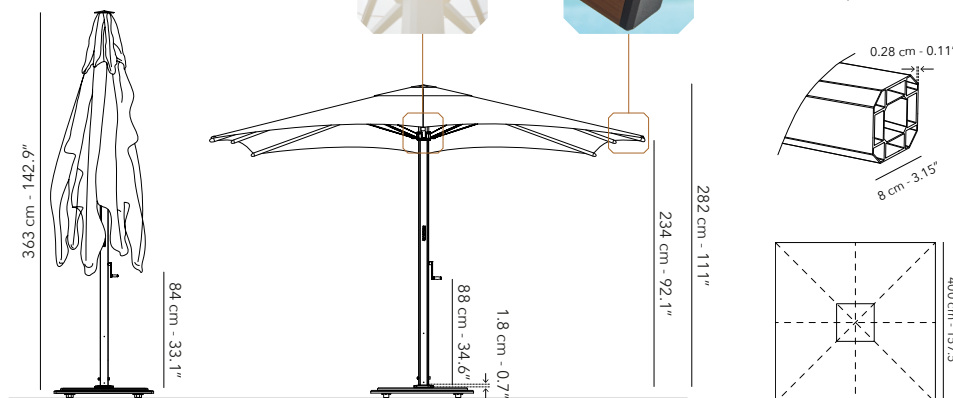
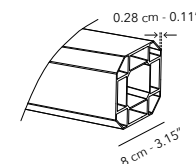
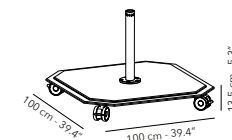

All dimensions exclude the base. - Toutes les dimensions excluent la base. - Alle afmetingen zijn exclusief de parasolvoet.

\* Easy to open and close without touching furniture. - Facile à ouvrir et à fermer sans toucher les meubles.

Makkelijk te openen en te sluiten zonder meubelen te raken.

Center pole frame, powder coated aluminium.  
Mât central, aluminium thermolaqué.  
Middenstam parasol, gepoederlakt aluminium.

Tilt and rotation not applicable.  
Inclinaison non applicable.  
Kantelen en roteren niet van toepassing.

Powder coated hot galvanized steel base with 360° rotating wheels, each with a brake.  
Base en acier galvanisé à chaud thermolaqué avec roues pivotant 360°, chacune avec un frein.  
Gepoederlakte, warme verzinkte staalplaten voet met 360° draaiende wielen, elk met een rem.

# JCP.2 SERIES

max. 58 km/h, 36 mph

## JCP.202 - 500 X 500 CM

### UFJCP.202 FRAME - STRUCTURE

		Base Voet	IGB OGB
	A01 white		A31 charcoal
		choose category of fabric	choose category of fabric

### UCJCP.202 CANOPY - TOILE - DOEK

#### CATEGORY 3

		FAST STOCK	ON DEMAND
	C003 pearl		C011 cotton
	C022 Nile <b>NEW</b>		C207 onyx
	C210 pitch		C305 umber
		€ 6.555	€ 4.855

#### CATEGORY 2

	C019 tofu <b>NEW</b>		C023 heather <b>NEW</b>
		€ 6.095	€ 4.395

#### CATEGORY 3

see overview fabrics on p. 81 - minimum 2 umbrellas / colour	€ 6.555	€ 4.855
--	---------	---------

#### CATEGORY 2

see overview fabrics on p. 82	€ 6.095	€ 4.395
-------------------------------	---------	---------

### UBJCP.25-35-A BASE - PARASOLVOET

	S01 white		S31 charcoal	incl.	/
--	-----------	--	--------------	-------	---

### UBIGB-JCP.25-35 in ground base - ancre de sol - grondanker OR/OU/OF

UBOGB-JCP.25-35 on ground base - plaque de fixation - bevestigingsplaat	/	incl.
---	---	-------

### UAJCP.25-35 in/on ground base plate cover - couvercle de la plaque - afdekplaat (same colours as base) **OPTIONAL**

	/	€ 99
--	---	------

### COVER - HOUSSE - HOES

	UPJCP.25-X77 black	incl.	incl.
---	--------------------	-------	-------

### GUTTERS - GOUÏTIÈRES - GOTEN

UAJCP.25 colour of the canopy - couleur de la toile - kleur van het doek	€ 595 / pc.
--	-------------

	frame	base
nett weight	56 kg, 123.5 lbs	158 kg, 348 lbs
gross weight	59 kg, 130 lbs	167 kg, 368.2 lbs
	370 x 38 x 38 cm, 0.53 cbm	103 x 103 x 17 cm, 0.18 cbm



Telescopic hub system\*



LOXX® system

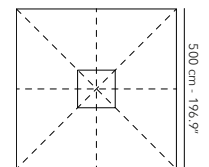
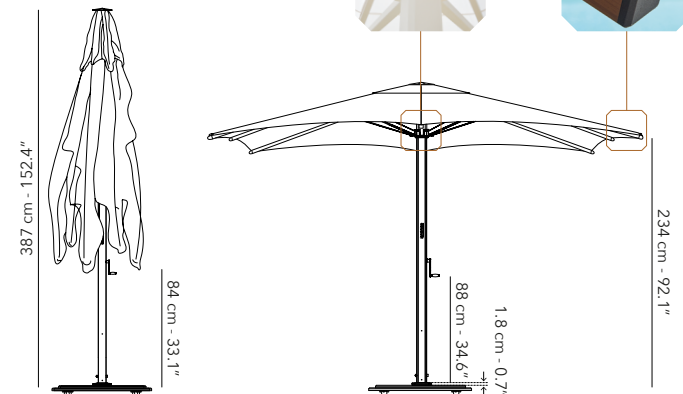
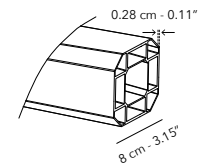
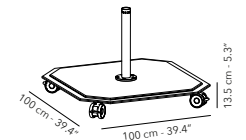

All dimensions exclude the base. - Toutes les dimensions excluent la base. - Alle afmetingen zijn exclusief de parasolvoet.

\* Easy to open and close without touching furniture. - Facile à ouvrir et à fermer sans toucher les meubles.

Makkelijk te openen en te sluiten zonder meubelen te raken.

# JCP.2 SERIES

Center pole frame, powder coated aluminium.  
Mât central, aluminium thermolaqué.  
Middenstam parasol, gepoederlakt aluminium.

Tilt and rotation not applicable.  
Inclinaison non applicable.  
Kantelen en roteren niet van toepassing.

Powder coated hot galvanized steel base with 360° rotating wheels, each with a brake.  
Base en acier galvanisé à chaud thermolaqué avec roues pivotant 360°, chacune avec un frein.  
Gepoederlakte, warme verzinkte staalplaten voet met 360° draaiende wielen, elk met een rem.

max. 58 km/h, 36 mph

## JCP.203 - Ø 450 CM

### UFJCP.203 FRAME - STRUCTURE

		Base Voet	IGB OGB
	A01 white		A31 charcoal
		choose category of fabric	choose category of fabric

### UCJCP.203 CANOPY - TOILE - DOEK

#### CATEGORY 3

		FAST STOCK	
	C003 pearl		C011 cotton
	C022 Nile <b>NEW</b>		C207 onyx
	C210 pitch		C305 umber
		€ 5.995	€ 4.295

#### CATEGORY 2

	C019 tofu <b>NEW</b>		C023 heather <b>NEW</b>
		€ 5.595	€ 3.895

#### CATEGORY 3

see overview fabrics on p. 81 - minimum 3 umbrellas / colour	€ 5.995	€ 4.295
--	---------	---------

#### CATEGORY 2

see overview fabrics on p. 82	€ 5.595	€ 3.895
-------------------------------	---------	---------

### UBJCP.25-35-A BASE - PARASOLVOET

	S01 white		S31 charcoal	incl.	/
--	-----------	--	--------------	-------	---

UBIGB-JCP.25-35 in ground base - ancre de sol - grondanker **OR/OU/OF**

UBOGB-JCP.25-35 on ground base - plaque de fixation - bevestigingsplaat

UAJCP.25-35 in/on ground base plate cover - couvercle de la plaque - afdekplaat (same colours as base) **OPTIONAL**

	/	incl.
	/	€ 99

### COVER - HOUSSE - HOES

	UPJCP.25-X77 black	incl.	incl.
---	--------------------	-------	-------

### GUTTERS - GOUÏTIÈRES - GOTEN

UAJCP.25 colour of the canopy - couleur de la toile - kleur van het doek	€ 595 /pc.
--	------------

	frame	base
nett weight	42 kg, 92.6 lbs	158 kg, 348 lbs
gross weight	44.5 kg, 98.1 lbs	167 kg, 368.2 lbs
	370 x 38 x 38 cm, 0.53 cbm	103 x 103 x 17 cm, 0.18 cbm



Telescopic hub system\*



LOXX® system

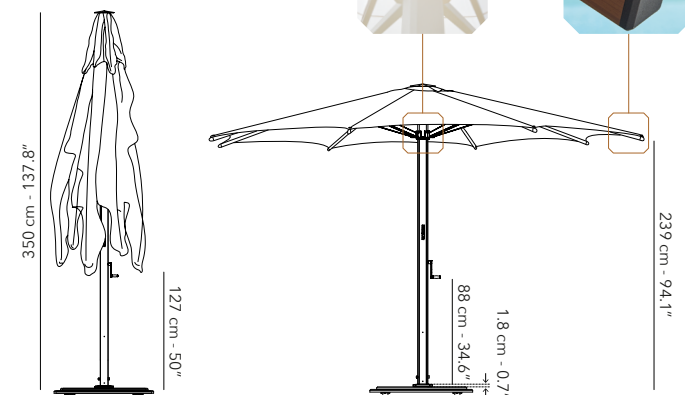
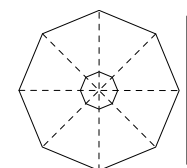
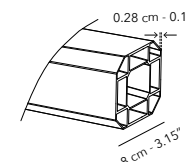
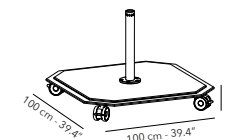

All dimensions exclude the base. - Toutes les dimensions excluent la base. - Alle afmetingen zijn exclusief de parasolvoet.

\* Easy to open and close without touching furniture. - Facile à ouvrir et à fermer sans toucher les meubles.

Makkelijk te openen en te sluiten zonder meubelen te raken.



Free pole frame, powder coated aluminium.  
Mât déporté, aluminium thermolaqué.  
Vrijhangende parasol, gepoederlakt aluminium.

Tilt in height, left and right, rotation 360°.  
Inclinable en hauteur, à gauche & droite, rotation de 360°.  
Kantelen in de hoogte, links & rechts, 360° rotatie.

Hot galvanized steel base with 360° rotating wheels, each with a brake.  
Base en acier galvanisé avec roues pivotant 360°, chacune avec un frein.  
Warme verzinkte staalplaten voet met 360° draaiende wielen, elk met een rem.

# JCP.3 SERIES

UPDATED - LED



max. 58 km/h, 36 mph

## JCP.301 - 300 X 300 CM

UFJCP.301 FRAME - STRUCTURE				Base Voet	IGB OGB	Base - Voet LED	IGB - OGB LED
	A03 linen		A31 charcoal	choose category of fabric	choose category of fabric	choose category of fabric*	choose category of fabric*
	A01 white		A10 cappuccino				
	A12 alu teak		A32 black				

### UCJCP.301 CANOPY - TOILE - DOEK

#### CATEGORY 3

	C003 pearl		C011 cotton	€ 5.295	€ 3.595	€ 5.995	€ 4.295
	C022 Nile <b>NEW</b>		C207 onyx				
	C210 pitch		C305 umber				

#### CATEGORY 2

	C019 tofu <b>NEW</b>		C023 heather <b>NEW</b>	€ 4.995	€ 3.295	€ 5.695	€ 3.995
--	----------------------	--	-------------------------	---------	---------	---------	---------

#### CATEGORY 3

ON DEMAND	see overview fabrics on p. 81 - minimum 5 umbrellas / colour	€ 5.295	€ 3.595	€ 5.995	€ 4.295
-----------	--	---------	---------	---------	---------

#### CATEGORY 2

ON DEMAND	see overview fabrics on p. 82	€ 4.995	€ 3.295	€ 5.695	€ 3.995
-----------	-------------------------------	---------	---------	---------	---------

### UBJCP.25-35-A BASE - PARASOLVOET

	S01 white		S03 linen	incl.	/	incl.	/
	S31 charcoal		S32 black				

Has the same colour as its frame. An alu teak or cappuccino frame has a charcoal base.  
La même couleur que la structure. Un mât couleur alu teak ou cappuccino a une base charcoal.  
Heeft dezelfde kleur als het frame. Een frame in alu teak of cappuccino heeft een charcoal parasolvoet.

OPT.	UBIGB-JCP.25-35 in ground base - ancre de sol - grondanker <b>OR/OU/OF</b>	/	incl.	/	incl.
	UBOGB-JCP.25-35 on ground base - plaque de fixation - bevestigingsplaat				
	UAJCP.25-35 in/on ground base plate cover - couvercle de la plaque - afdekplaat (same colours as base) <b>OPTIONAL</b>	/	€ 99	/	€ 99

### COVER - HOUSSE - HOES

	UPJCP.35-X77 black	incl.	incl.	incl.	incl.
--	--------------------	-------	-------	-------	-------

	frame	base
nett weight	42 kg, 92.6 lbs	158 kg, 348 lbs
gross weight	44.5 kg, 98.1 lbs	167 kg, 368.2 lbs
	370 x 38 x 38 cm, 0.53 cbm	103 x 103 x 17 cm, 0.18 cbm

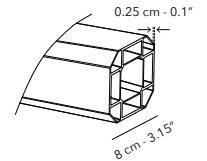
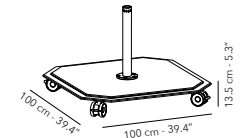

Slider & crank handle



LOXX® system

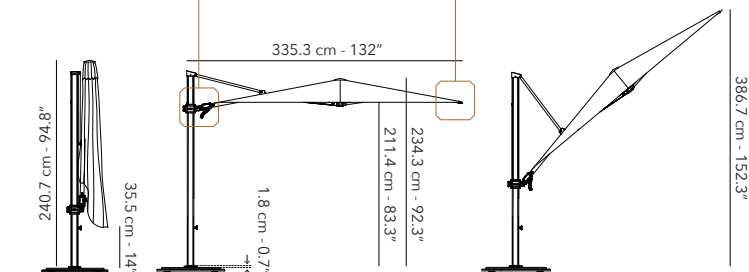
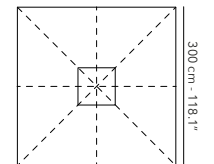

All dimensions exclude the base. - Toutes les dimensions excluent la base. - Alle afmetingen zijn exclusief de parasolvoet.

MIX & MATCH

FAST STOCK

ON DEMAND

OPT.

# JCP.3 SERIES

Free pole frame, powder coated aluminium.  
Mât déporté, aluminium thermolaqué.  
Vrijhangende parasol, gepoederlakt aluminium.

Tilt in height, left and right, rotation 360°.  
Inclinable en hauteur, à gauche & droite, rotation de 360°.  
Kantelen in de hoogte, links & rechts, 360° rotatie.

Hot galvanized steel base with 360° rotating wheels, each with a brake.  
Base en acier galvanisé avec roues pivotant 360°, chacune avec un frein.  
Warme verzinkte staalplaten voet met 360° draaiende wielen, elk met een rem.



max. 58 km/h, 36 mph

## JCP.302 - 260 X 260 CM

### UFJCP.302 FRAME - STRUCTURE

		Base Voet	IGB OGB
	A01 white		A10 cappuccino
	A12 alu teak		A31 charcoal
		choose category of fabric	choose category of fabric

### UCJCP.302 CANOPY - TOILE - DOEK

#### CATEGORY 3

		€ 4.795	€ 3.095
	C003 pearl		C011 cotton
	C022 Nile <b>NEW</b>		C207 onyx
	C210 pitch		C305 umber

#### CATEGORY 2

	C019 tofu <b>NEW</b>		C023 heather <b>NEW</b>	€ 4.545	€ 2.845
--	----------------------	--	-------------------------	---------	---------

#### CATEGORY 3

ON DEMAND	see overview fabrics on p. 81 - minimum 7 umbrellas / colour	€ 4.795	€ 3.095
-----------	--	---------	---------

#### CATEGORY 2

ON DEMAND	see overview fabrics on p. 82	€ 4.545	€ 2.845
-----------	-------------------------------	---------	---------

### UBJCP.2S-3S-A BASE - PARASOLVOET

	S01 white		S31 charcoal	incl.	/
--	-----------	--	--------------	-------	---

Has the same colour as its frame. An alu teak or cappuccino frame has a charcoal base.  
La même couleur que la structure. Un mât couleur alu teak ou cappuccino a une base charcoal.  
Heeft dezelfde kleur als het frame. Een frame in alu teak of cappuccino heeft een charcoal parasolvoet.

UBIGB-JCP.2S-3S in ground base - ancre de sol - grondanker OR/OU/OF	/	incl.
---	---	-------

UBOGB-JCP.2S-3S on ground base - plaque de fixation - bevestigingsplaat	/	incl.
---	---	-------

OPT. UAJCP.2S-3S in/on ground base plate cover - couvercle de la plaque - afdekplaat (same colours as base) <b>OPTIONAL</b>	/	€ 99
---	---	------

### COVER - HOUSSE - HOES

	UPJCP.3S-X77 black	incl.	incl.
--	--------------------	-------	-------

	frame	base
nett weight	31 kg, 68.3 lbs	158 kg, 348 lbs
gross weight	34 kg, 75 lbs	167 kg, 368.2 lbs
	252 x 40 x 20 cm, 0.2 cbm	103 x 103 x 17 cm, 0.18 cbm



Slider & crank handle



LOXX® system

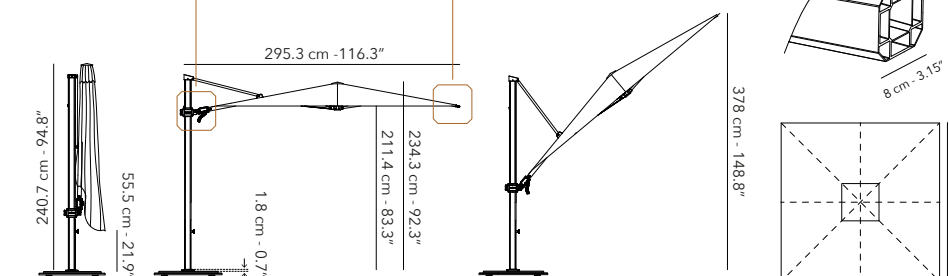
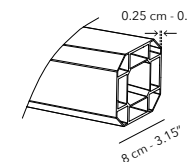
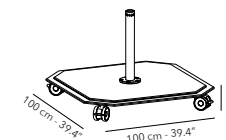

All dimensions exclude the base. - Toutes les dimensions excluent la base. - Alle afmetingen zijn exclusief de parasolvoet.

Free pole frame, powder coated aluminium.  
Mât déporté, aluminium thermolaqué.  
Vrijhangende parasol, gepoederlakt aluminium.

Tilt in height, left and right, rotation 360°.  
Inclinable en hauteur, à gauche & droite, rotation de 360°.  
Kantelen in de hoogte, links & rechts, 360° rotatie.

Hot galvanized steel base with 360° rotating wheels, each with a brake.  
Base en acier galvanisé avec roues pivotant 360°, chacune avec un frein.  
Warme verzinkte staalplaten voet met 360° draaiende wielen, elk met een rem.

# JCP.3 SERIES



max. 58 km/h, 36 mph

## JCP.303 - Ø 350 CM

### UFJCP.303 FRAME - STRUCTURE

		Base Voet	IGB OGB
	A01 white	choose category of fabric	choose category of fabric
	A10 cappuccino		
	A31 charcoal		
	A03 linen	choose category of fabric	choose category of fabric
	A12 alu teak		

### UCJCP.303 CANOPY - TOILE - DOEK

#### CATEGORY 3

	C003 pearl		C011 cotton	€ 5.295	€ 3.595
	C022 Nile <b>NEW</b>		C207 onyx		
	C210 pitch		C305 umber		

#### CATEGORY 2

	C019 tofu <b>NEW</b>		C023 heather <b>NEW</b>	€ 4.995	€ 3.295
--	----------------------	--	-------------------------	---------	---------

#### ON DEMAND

CATEGORY 3	see overview fabrics on p. 81 - minimum 6 umbrellas / colour	€ 5.295	€ 3.595
CATEGORY 2	see overview fabrics on p. 82	€ 4.995	€ 3.295

### UBJCP.25-35-A BASE - PARASOLVOET

	S01 white		S31 charcoal	incl.	/
	S03 linen				

Has the same colour as its frame. An alu teak or cappuccino frame has a charcoal base.  
La même couleur que la structure. Un mât couleur alu teak ou cappuccino a une base charcoal.  
Heeft dezelfde kleur als het frame. Een frame in alu teak of cappuccino heeft een charcoal parasolvoet.

#### OPT.

UBIGB-JCP.25-35 in ground base - ancre de sol - grondanker <b>OR/OU/OF</b>	/	incl.
UBOGB-JCP.25-35 on ground base - plaque de fixation - bevestigingsplaat	/	incl.
UAJCP.25-35 in/on ground base plate cover - couvercle de la plaque - afdekplaat (same colours as base) <b>OPTIONAL</b>	/	€ 99

### COVER - HOUSSE - HOES

	UPJCP.35-X77 black	incl.	incl.
--	--------------------	-------	-------

	frame	base
nett weight	34 kg, 75 lbs	158 kg, 348 lbs
gross weight	36.5 kg, 80.5 lbs	167 kg, 368.2 lbs
	252 x 40 x 20 cm, 0.2 cbm	103 x 103 x 17 cm, 0.18 cbm



Slider & crank handle



LOXX® system

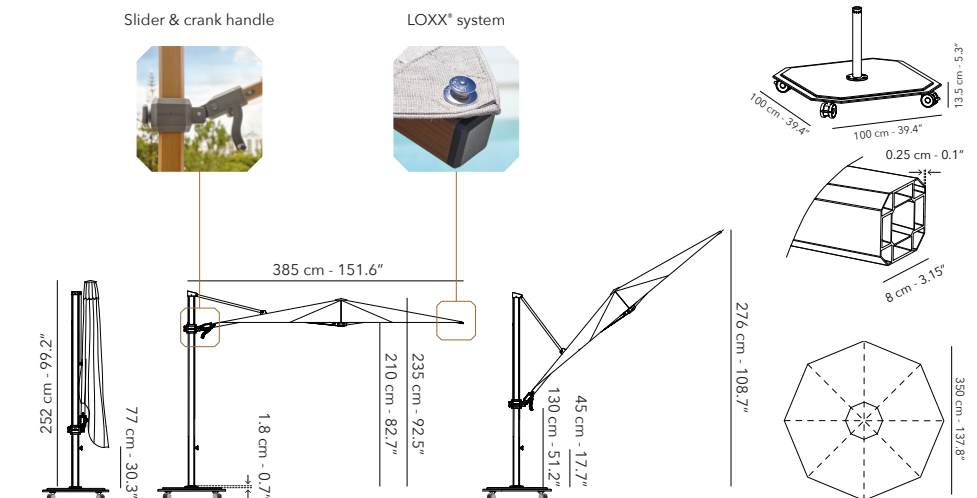

All dimensions exclude the base. - Toutes les dimensions excluent la base. - Alle afmetingen zijn exclusief de parasolvoet.

# JCP.4 SERIES

Free pole frame, powder coated aluminium.  
Mât déporté, aluminium thermolaqué.  
Vrijhangende parasol, gepoederlakt aluminium.

Tilt in height, rotation 360°.  
Inclinable en hauteur, rotation de 360°.  
Kantelen in de hoogte, 360° rotatie.

Powder coated hot galvanized steel base with 360° rotating wheels, each with a brake.  
Base en acier galvanisé à chaud thermolaqué avec roues pivotant 360°, chacune avec un frein.  
Gepoederlakte, warme verzinkte staalplaten voet met 360° draaiende wielen, elk met een rem.



max. 58 km/h, 36 mph

## JCP.401 - 370 X 370 CM

### UFJCP.401 FRAME - STRUCTURE

		Base Voet	IGB OGB
	A01 white	choose category of fabric	choose category of fabric
	A03 linen		
	A10 cappuccino		
	A12 alu teak		
	A31 charcoal		
	A32 black		

### UCJCP.401 CANOPY - TOILE - DOEK

#### CATEGORY 3

		€ 7.995	€ 5.995
	C003 pearl		
	C022 Nile <b>NEW</b>		
	C207 onyx		
	C210 pitch		
	C305 umber		

#### CATEGORY 2

	C019 tofu <b>NEW</b>	€ 7.595	€ 5.595
	C023 heather <b>NEW</b>		

#### CATEGORY 3

see overview fabrics on p. 81 - minimum 3 umbrellas / colour	€ 7.995	€ 5.995
--	---------	---------

#### CATEGORY 2

see overview fabrics on p. 82	€ 7.595	€ 5.595
-------------------------------	---------	---------

### UBJCP.45S BASE - PARASOLVOET

		incl.	/
	S01 white		
	S03 linen		
	S31 charcoal		
	S32 black		

Has the same colour as its frame. An alu teak or cappuccino frame has a charcoal base.  
La même couleur que la structure. Un mât couleur alu teak ou cappuccino a une base charcoal.  
Heeft dezelfde kleur als het frame. Een frame in alu teak of cappuccino heeft een charcoal parasolvoet.

UBIGB-JCP.45S-5S-6S in ground base - ancre de sol - grondanker <b>OR/OU/OF</b>	/	incl.
UBOGB-JCP.45S-5S-6S on ground base - plaque de fixation - bevestigingsplaat		

### COVER - HOUSSE - HOES

	UPJCP.45S-X77 black	incl.	incl.
--	---------------------	-------	-------

	frame	base
nett weight	64 kg, 141.1 lbs	245 kg, 540.1 lbs
gross weight	67 kg, 147.7 lbs	254 kg, 560 lbs
	275 x 50 x 28 cm, 0.39 cbm	103 x 103 x 20 cm, 0.21 cbm



Slider & crank handle



LOXX® system

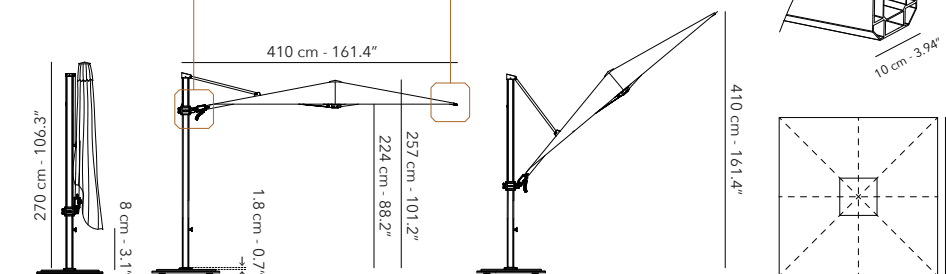
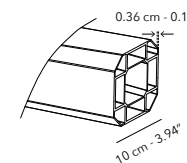
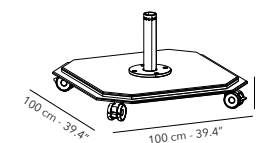

All dimensions exclude the base. - Toutes les dimensions excluent la base. - Alle afmetingen zijn exclusief de parasolvoet.

MIX & MATCH

FAST STOCK

ON DEMAND

Free pole frame, powder coated aluminium.  
Mât déporté, aluminium thermolaqué.  
Vrijhangende parasol, gepoederlakt aluminium.

Tilt in height, rotation 360°.  
Inclinable en hauteur, rotation de 360°.  
Kantelen in de hoogte, 360° rotatie.

Powder coated hot galvanized steel base with 360° rotating wheels, each with a brake.  
Base en acier galvanisé à chaud thermolaqué avec roues pivotant 360°, chacune avec un frein.  
Gepoederlakte, warme verzinkte staalplaten voet met 360° draaiende wielen, elk met een rem.

# JCP.4 SERIES



max. 58 km/h, 36 mph

## JCP.402 - 425 X 300 CM

### UFJCP.402 FRAME - STRUCTURE

UFJCP.402 FRAME - STRUCTURE		Base Voet	IGB OGB
	A01 white	choose category of fabric	choose category of fabric
	A03 linin		
	A10 cappuccino		
	A12 alu teak		
	A31 charcoal		

### UCJCP.402 CANOPY - TOILE - DOEK

#### CATEGORY 3

UCJCP.402 CANOPY - TOILE - DOEK			
	C003 pearl	€ 7.995	€ 5.995
	C022 Nile <b>NEW</b>		
	C207 onyx		
	C210 pitch		
	C305 umber		

#### CATEGORY 2

	C019 tofu <b>NEW</b>	€ 7.595	€ 5.595
	C023 heather <b>NEW</b>		

#### CATEGORY 3

see overview fabrics on p. 81 - minimum 4 umbrellas / colour	€ 7.995	€ 5.995
--	---------	---------

#### CATEGORY 2

see overview fabrics on p. 82	€ 7.595	€ 5.595
-------------------------------	---------	---------

### UBJCP.45 BASE - PARASOLVOET

UBJCP.45 BASE - PARASOLVOET			
	S01 white	incl.	/
	S03 linin		
	S31 charcoal		

Has the same colour as its frame. An alu teak or cappuccino frame has a charcoal base.  
La même couleur que la structure. Un mât couleur alu teak ou cappuccino a une base charcoal.  
Heeft dezelfde kleur als het frame. Een frame in alu teak of cappuccino heeft een charcoal parasolvoet.

UBIGB-JCP.45-55-65 in ground base - ancre de sol - grondanker <b>OR/OU/OF</b>	/	incl.
UBOGB-JCP.45-55-65 on ground base - plaque de fixation - bevestigingsplaat		

### COVER - HOUSSE - HOES

	UPJCP.45-X77 black	incl.	incl.
--	--------------------	-------	-------

	frame	base
nett weight	53 kg, 116.8 lbs	245 kg, 540.1 lbs
gross weight	56 kg, 123.5 lbs	254 kg, 560 lbs
	275 x 50 x 28 cm, 0.39 cbm	103 x 103 x 20 cm, 0.21 cbm



Slider & crank handle



LOXX® system

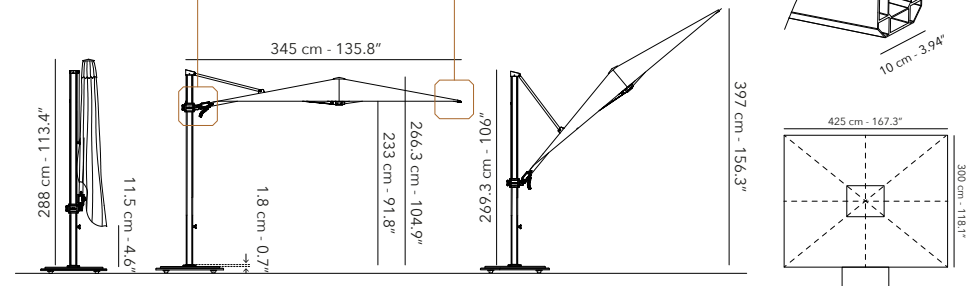
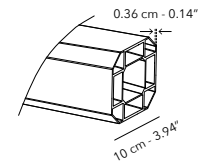
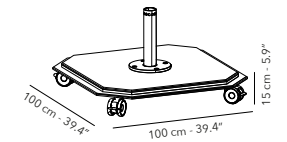

All dimensions exclude the base. - Toutes les dimensions excluent la base. - Alle afmetingen zijn exclusief de parasolvoet.

MIX & MATCH

FAST STOCK

ON DEMAND

# JCP.4 SERIES

Free pole frame, powder coated aluminium.  
Mât déporté, aluminium thermolaqué.  
Vrijhangende parasol, gepoederlakt aluminium.

Tilt in height, rotation 360°.  
Inclinable en hauteur, rotation de 360°.  
Kantelen in de hoogte, 360° rotatie.

Powder coated hot galvanized steel base with 360° rotating wheels, each with a brake.  
Base en acier galvanisé à chaud thermolaqué avec roues pivotant 360°, chacune avec un frein.  
Gepoederlakte, warme verzinkte staalplaten voet met 360° draaiende wielen, elk met een rem.



max. 58 km/h, 36 mph

## JCP.403 - Ø 400 CM

### UFJCP.403 FRAME - STRUCTURE

		Base Voet	IGB OGB
	A01 white	choose category of fabric	choose category of fabric
	A10 cappuccino		
	A12 alu teak	choose category of fabric	choose category of fabric
	A31 charcoal		

### UCJCP.403 CANOPY - TOILE - DOEK

#### CATEGORY 3

		€ 7.495	€ 5.495
	C003 pearl	€ 7.495	€ 5.495
	C011 cotton		
	C022 Nile <b>NEW</b>		
	C207 onyx		
	C210 pitch		
	C305 umber		

#### CATEGORY 2

	C019 tofu <b>NEW</b>	€ 7.145	€ 5.145
	C023 heather <b>NEW</b>		

#### CATEGORY 3

ON DEMAND	see overview fabrics on p. 81 - minimum 4 umbrellas / colour	€ 7.495	€ 5.495
-----------	--	---------	---------

#### CATEGORY 2

ON DEMAND	see overview fabrics on p. 82	€ 7.145	€ 5.145
-----------	-------------------------------	---------	---------

### UBJCP.45 BASE - PARASOLVOET

	S01 white		S31 charcoal	incl.	/
--	-----------	--	--------------	-------	---

Has the same colour as its frame. An alu teak or cappuccino frame has a charcoal base.  
La même couleur que la structure. Un mât couleur alu teak ou cappuccino a une base charcoal.  
Heeft dezelfde kleur als het frame. Een frame in alu teak of cappuccino heeft een charcoal parasolvoet.

UBIGB-JCP.45-5S-6S in ground base - ancre de sol - grondanker	OR/OU/OF	/	incl.
UBOGB-JCP.45-5S-6S on ground base - plaque de fixation - bevestigingsplaat			

### COVER - HOUSSE - HOES

	UPJCP.45-X77 black	incl.	incl.
--	--------------------	-------	-------

	frame	base
nett weight	53 kg, 116.8 lbs	245 kg, 540.1 lbs
gross weight	56 kg, 123.5 lbs	254 kg, 560 lbs
	275 x 50 x 28 cm, 0.39 cbm	103 x 103 x 20 cm, 0.21 cbm



Slider & crank handle



LOXX® system

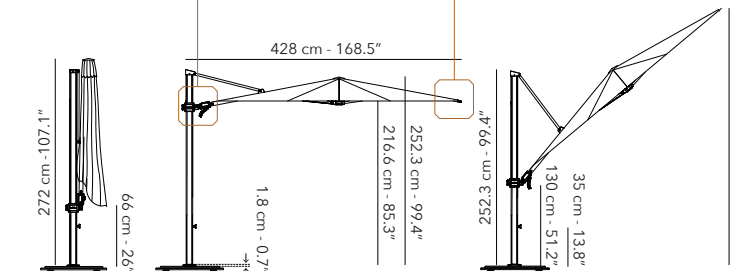
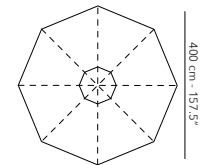
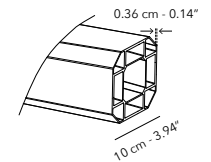
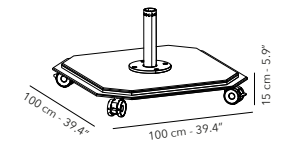

All dimensions exclude the base. - Toutes les dimensions excluent la base. - Alle afmetingen zijn exclusief de parasolvoet.



Free pole frame, powder coated aluminium.  
Mât déporté, aluminium thermolaqué.  
Vrijhangende parasol, gepoederlakt aluminium.

Tilt in height, rotation 360°.  
Inclinable en hauteur, rotation de 360°.  
Kantelen in de hoogte, 360° rotatie.

Powder coated hot galvanized steel base with 360° rotating wheels, each with a brake.  
Base en acier galvanisé à chaud thermolaqué avec roues pivotant 360°, chacune avec un frein.  
Gepoederlakte, warme verzinkte staalplaten voet met 360° draaiende wielen, elk met een rem.

# JCP.4 SERIES



max. 58 km/h, 36 mph

## JCP.404 - 250 X 350 CM

### UFJCP.404 FRAME - STRUCTURE

UFJCP.404 FRAME - STRUCTURE		Base Voet	IGB OGB
	A01 white	choose category of fabric	choose category of fabric
	A03 linen		
	A10 cappuccino		
	A12 alu teak		
	A31 charcoal		

### UCJCP.404 CANOPY - TOILE - DOEK

#### CATEGORY 3

UCJCP.404 CANOPY - TOILE - DOEK		Base Voet	IGB OGB
	C003 pearl	€ 6.795	€ 4.795
	C011 cotton		
	C022 Nile <b>NEW</b>		
	C207 onyx		
	C210 pitch		
	C305 umber		

#### CATEGORY 2

	C019 tofu <b>NEW</b>	€ 6.495	€ 4.495
	C023 heather <b>NEW</b>		

#### ON DEMAND

CATEGORY 3	see overview fabrics on p. 81 - minimum 5 umbrellas / colour	€ 6.795	€ 4.795
------------	--	---------	---------

CATEGORY 2	see overview fabrics on p. 82	€ 6.495	€ 4.495
------------	-------------------------------	---------	---------

### UBJCP.45S BASE - PARASOLVOET

UBJCP.45S BASE - PARASOLVOET		Base Voet	IGB OGB
	S01 white	incl.	/
	S03 linen		
	S31 charcoal		

Has the same colour as its frame. An alu teak or cappuccino frame has a charcoal base.  
La même couleur que la structure. Un mât couleur alu teak ou cappuccino a une base charcoal.  
Heeft dezelfde kleur als het frame. Een frame in alu teak of cappuccino heeft een charcoal parasolvoet.

UBIGB-JCP.45-55-65 in ground base - ancre de sol - grondanker <b>OR/OU/OF</b>	/		incl.
UBOGB-JCP.45-55-65 on ground base - plaque de fixation - bevestigingsplaat			

### COVER - HOUSSE - HOES

	UPJCP.45-X77 black	incl.	incl.
--	--------------------	-------	-------

	frame	base
nett weight	53 kg, 116.8 lbs	245 kg, 540.1 lbs
gross weight	56 kg, 123.5 lbs	254 kg, 560 lbs
	275 x 50 x 28 cm, 0.39 cbm	103 x 103 x 20 cm, 0.21 cbm



Slider & crank handle



LOXX® system

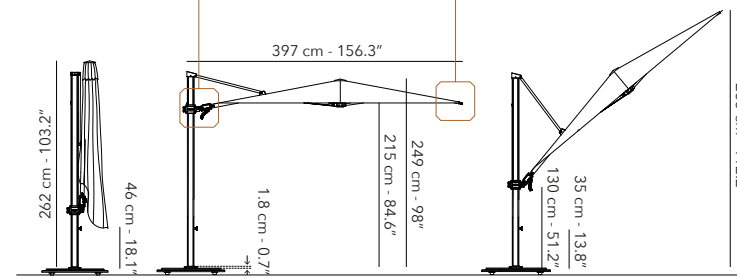
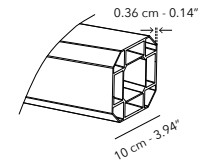
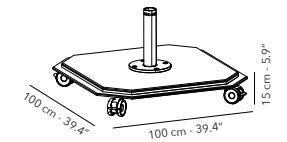

All dimensions exclude the base. - Toutes les dimensions excluent la base. - Alle afmetingen zijn exclusief de parasolvoet.

# JCP.5 SERIES

Free pole frame, powder coated aluminium.  
Mât déporté, aluminium thermolaqué.  
Vrijhangende parasol, gepoederlakt aluminium.

Tilt in height, rotation 360°.  
Inclinable en hauteur, rotation de 360°.  
Kantelen in de hoogte, 360° rotatie.

Powder coated hot galvanized steel base with 360° rotating wheels, each with a brake.  
Base en acier galvanisé à chaud thermolaqué avec roues pivotant 360°, chacune avec un frein.  
Gepoederlakte, warme verzinkte staalplaten voet met 360° draaiende wielen, elk met een rem.



max. 58 km/h, 36 mph

## JCP.501 - 4\* 300 X 300 CM

### UFJCP.501 FRAME - STRUCTURE

		Base Voet	IGB OGB
	A12 alu teak		A31 charcoal
		choose category of fabric	choose category of fabric

### UCJCP.501 CANOPY - TOILE - DOEK

#### CATEGORY 3

		€ 13.995	€ 10.995
	C003 pearl		C011 cotton
	C022 Nile <b>NEW</b>		C207 onyx
	C210 pitch		C305 umber

#### CATEGORY 2

	C019 tofu <b>NEW</b>		C023 heather <b>NEW</b>
		€ 12.795	€ 9.795

#### CATEGORY 3

see overview fabrics on p. 81 - minimum 1 umbrellas / colour	€ 13.995	€ 10.995
--	----------	----------

#### CATEGORY 2

see overview fabrics on p. 82	€ 12.795	€ 9.795
-------------------------------	----------	---------

### UBJCP.55-6S BASE - PARASOLVOET

	S31 charcoal	incl.	/
--	--------------	-------	---

Has the same colour as its frame. An alu teak or cappuccino frame has a charcoal base.  
La même couleur que la structure. Un mât couleur alu teak ou cappuccino a une base charcoal.  
Heeft dezelfde kleur als het frame. Een frame in alu teak of cappuccino heeft een charcoal parasolvoet.

UBIGB-JCP.4S-5S-6S in ground base - ancre de sol - grondanker <b>OR/OU/OF</b>	/	incl.
UBOGB-JCP.4S-5S-6S on ground base - plaque de fixation - bevestigingsplaat		

### COVER - HOUSSE - HOES

	UPJCP.5S-X77 black	incl.	incl.
--	--------------------	-------	-------

### UAJCP.5S GUTTERS - GOUTTIÈRES - GOTEN (4x)

A fabric from our fast stock - Un tissu du fast stock - Een stof uit fast stock	€ 1.295
Other fabric of your choice - Autre tissu de votre choix - Stof naar keuze	€ 1.395

	frame	base
nett weight	143.5 kg, 316.4 lbs	300 kg, 661 lbs
gross weight	154.5 kg, 340.5 lbs	309 kg, 681.2 lbs
	244 x 40 x 40 cm, 0.39 cbm	120 x 120 x 10 cm, 0.14 cbm



Slider & crank handle



LOXX® system

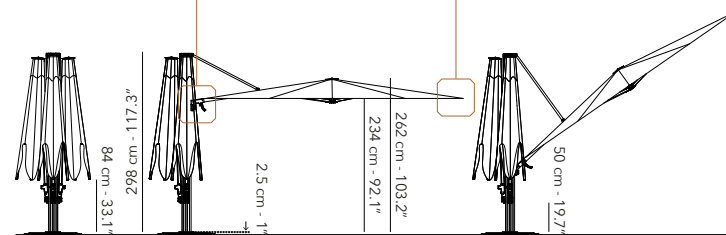
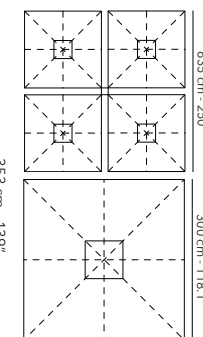
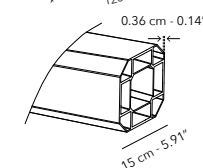
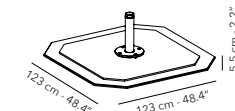

All dimensions exclude the base. - Toutes les dimensions excluent la base. - Alle afmetingen zijn exclusief de parasolvoet.

Free pole frame, powder coated aluminium.  
Mât déporté, aluminium thermolaqué.  
Vrijhangende parasol, gepoederlakt aluminium.

Tilt in height, rotation 360°.  
Inclinable en hauteur, rotation de 360°.  
Kantelen in de hoogte, 360° rotatie.

Powder coated hot galvanized steel base with 360° rotating wheels, each with a brake.  
Base en acier galvanisé à chaud thermolaqué avec roues pivotant 360°, chacune avec un frein.  
Gepoederlakte, warme verzinkte staalplaten voet met 360° draaiende wielen, elk met een rem.

# JCP.6 SERIES



max. 58 km/h, 36 mph

## JCP.601 - 2\* 300 X 300 CM

### UFJCP.601 FRAME - STRUCTURE

		Base Voet	IGB OGB
	A10 cappuccino	choose category of fabric	choose category of fabric
	A12 alu teak		
	A31 charcoal		

### UCJCP.601 CANOPY - TOILE - DOEK

#### CATEGORY 3

		FAST STOCK	ON DEMAND
	C003 pearl	€ 11.995	€ 7.995
	C011 cotton		
	C022 Nile <b>NEW</b>		
	C207 onyx		
	C210 pitch		
	C305 umber		

#### CATEGORY 2

	C019 tofu <b>NEW</b>	€ 11.395	€ 7.395
	C023 heather <b>NEW</b>		

#### CATEGORY 3

see overview fabrics on p. 81 - minimum 3 umbrellas / colour	€ 11.995	€ 7.995
--	----------	---------

#### CATEGORY 2

see overview fabrics on p. 82	€ 11.395	€ 7.395
-------------------------------	----------	---------

### UBJCP.5S-6S BASE - PARASOLVOET

	S31 charcoal	incl.	/
--	--------------	-------	---

Has the same colour as its frame. An alu teak or cappuccino frame has a charcoal base.  
La même couleur que la structure. Un mât couleur alu teak ou cappuccino a une base charcoal.  
Heeft dezelfde kleur als het frame. Een frame in alu teak of cappuccino heeft een charcoal parasolvoet.

UBIGB-JCP.4S-5S-6S in ground base - ancre de sol - grondanker <b>OR/OU/OF</b>	/	incl.
UBOGB-JCP.4S-5S-6S on ground base - plaque de fixation - bevestigingsplaat		

### COVER - HOUSSE - HOES

	UPJCP.6S-X77 black	incl.	incl.
--	--------------------	-------	-------

	frame	base
nett weight	86.5 kg, 190.7 lbs	245 kg, 540.1 lbs
gross weight	93 kg, 205 lbs	254 kg, 560 lbs
	244 x 40 x 40 cm, 0.39 cbm	103 x 103 x 20 cm, 0.21 cbm



Slider & crank handle



LOXX® system

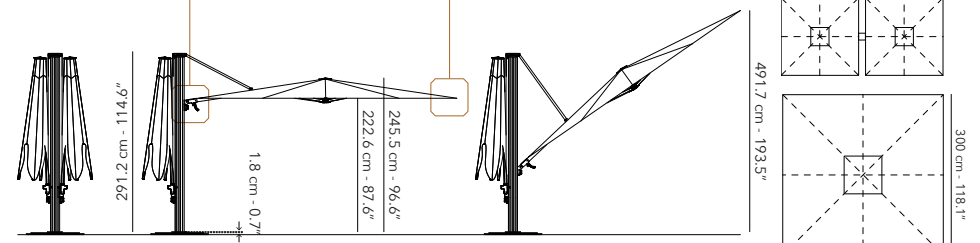
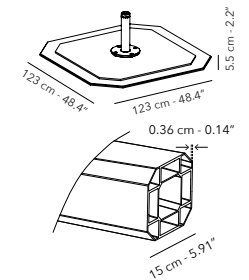

All dimensions exclude the base. - Toutes les dimensions excluent la base. - Alle afmetingen zijn exclusief de parasolvoet.

MIX & MATCH



OUTDOOR SHADE  
ATTITUDE

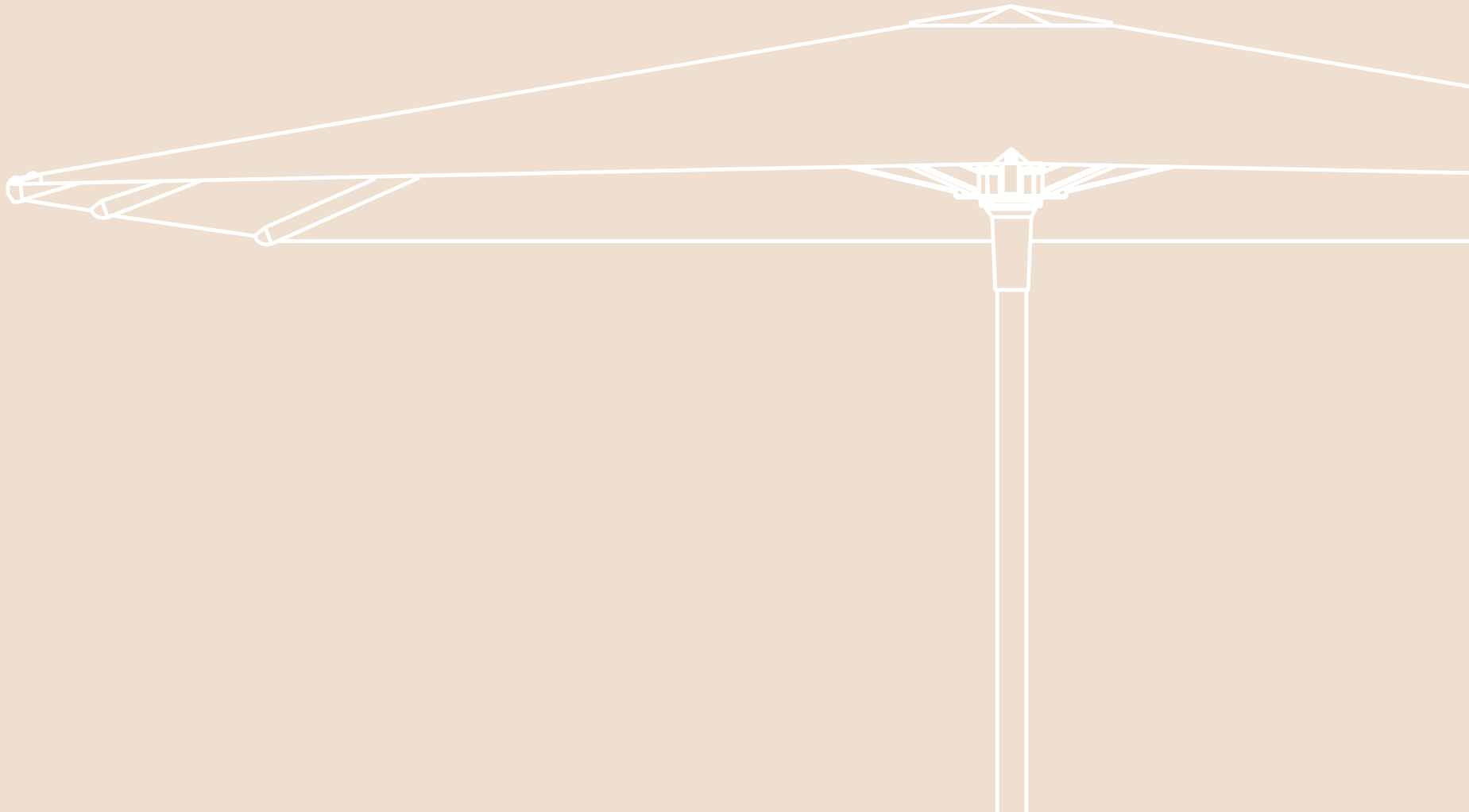





Free pole frame, powder coated aluminium.  
Mât déporté, aluminium thermolaqué.  
Vrijhangende parasol, gepoederlakt aluminium.

Canopy is weatherproof and colour resistant.  
Toile est résistant aux intempéries et aux couleurs.  
Doek is weerbestendig en kleurvast.

Tilt in height, left and right, rotation 360°.  
Inclinable en hauteur, à gauche et à droite, rotation de 360°.  
Kantelen in de hoogte, links & rechts, 360° rotatie.

AZORE

max. 27 km/h, 17 mph



**AZORE** fully assembled (excl. base)

UMAZO FRAME & CANOPY - STRUCTURE & TOILE - FRAME & DOEK 300 x 300

CATEGORY 1

		A01C101 white & cloud	€ 1.345
		A08C301 matt oak & taupe <b>NEW</b>	
		A30C204 anthracite & night	
		A32C208 black & black	

UB BASE - PARASOLVOET

BASES WITH OPTIONAL WHEELS

	AZO-120-NW-G04 azore	€ 465
OPTIONAL	AZO-EW60-G04 silk grey granite tiles - tuiles - tegels (p.44)	€ 495
	UABTEN-SP037-SET set of 4 stainless steel wheels	€ 199
	UABANT-SP037(A)-SET set of 4 synthetic wheels	€ 175

IGB / OGB

IGB-AZO-4G-MEDIUM in ground base - ancre de sol - grondanker	€ 245
OGB-AZO-4G-MEDIUM on ground base - plaque de fixation - bevestigingsplaat	€ 225

UP COVER - HOUSSE - HOES

AZO-M-X75 grey	incl.
----------------	-------

UA ACCESSORIES - ACCESSOIRES

LUN-LED02 Luna LED light - lumière - verlichting	€ 175
--	-------

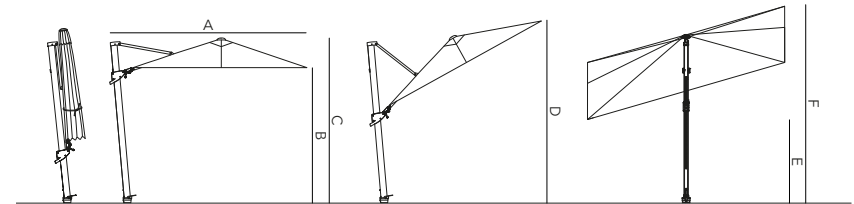

300 X 300 CM

	23.5 kg - 51.8 lbs nett 26.5 kg - 58.4 lbs gross excl. base - voet
	262 x 43 x 20 cm, 0.2 cbm excl. base - voet

A	375 cm - 147.6"
B	203 cm - 79.9"
C	262 cm - 103.1"
D	355 cm - 139.8"
E	130 cm - 51.2"
F	300 cm - 118.1"



300 x 300 cm

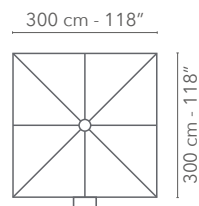

UBAZO-125-NW-G04  
AZORE  
SILK GREY GRANITE

125 kg, 275.6 lbs  
80 x 80 x 7 cm  
31.5 x 31.5 x 2.2"  
incl. wheels - roues - wielen

# ANTEGO

Free pole frame, powder coated aluminium.  
Mât déporté, aluminium thermolaqué.  
Vrijhangende parasol, gepoederlakt aluminium.

Canopy is weatherproof and colour resistant.  
Toile est résistant aux intempéries et aux couleurs.  
Doek is weerbestendig en kleurvast.

Tilt in height, left and right, rotation 360°.  
Inclinable en hauteur, à gauche et à droite, rotation de 360°.  
Kantelen in de hoogte, links & rechts, 360° rotatie.

max. 39 km/h, 24 mph

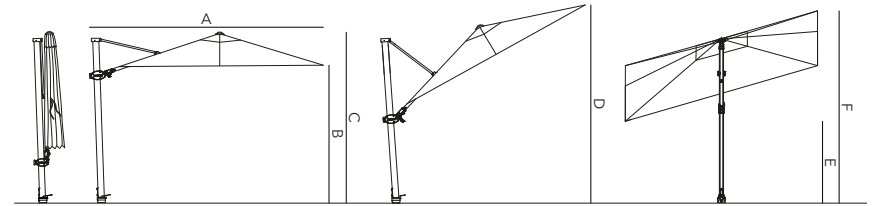
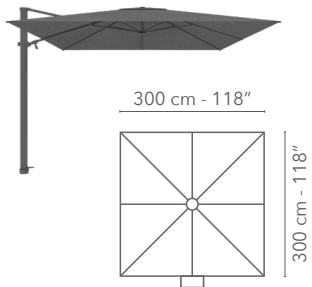
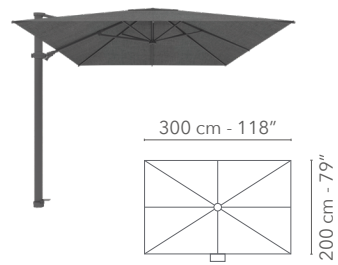

	300 X 200 CM	300 X 300 CM	Ø 350 CM
	26 kg - 57.3 lbs nett 30 kg - 66.1 lbs gross excl. base - voet	28 kg - 61.7 lbs nett 32 kg - 70.5 lbs gross excl. base - voet	27 kg - 59.5 lbs nett 31 kg - 68.3 lbs gross excl. base - voet
	267 x 42 x 18.5 cm, 0.2 cbm excl. base - voet	267 x 42 x 18.5 cm, 0.2 cbm excl. base - voet	267 x 42 x 18.5 cm, 0.2 cbm excl. base - voet
A	275 cm - 108.3"	375 cm - 147.6"	427 cm - 168.1"
B	203 cm - 79.9"	203 cm - 79.9"	188 cm - 74"
C	262 cm - 103.1"	262 cm - 103.1"	261 cm - 102.8"
D	280 cm - 110"	355 cm - 139.8"	441 cm - 173.6"
E	130 cm - 51.2"	130 cm - 51.2"	130 cm - 51.2"
F	300 cm - 118.1"	300 cm - 118.1"	375 cm - 92.5"



**UBANT-125-NW-G32**  
BLACK GRANITE

125 kg, 275.6 lbs  
92.5 x 92.5 x 5 cm,  
36.4 x 36.4 x 2"  
excl. wheels - roues - wielen



**UBANT-125-NW-G13**  
SANDSTONE

125 kg, 275.6 lbs  
92.5 x 92.5 x 5 cm,  
36.4 x 36.4 x 2"  
excl. wheels - roues - wielen



**UBANT-125-NW**  
CONCRETE

**A01** white **A03** linen  
**A30** anthracite **A32** black  
125 kg, 275.6 lbs  
92.5 x 92.5 x 5 cm, 36.4 x 36.4 x 2"  
excl. wheels - roues - wielen

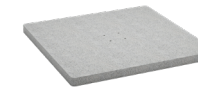

**UBANT-125-NW-G04**  
SILK GREY GRANITE

125 kg, 275.6 lbs  
92.5 x 92.5 x 5 cm,  
36.4 x 36.4 x 2"  
excl. wheels - roues - wielen  
optional: tegels - tuiles (p.29)









**UBANT-125**  
POWDER COATED STEEL

**A01** white **A03** linen  
**A30** anthracite **A32** black  
125 kg, 275.6 lbs  
92.5 x 92.5 x 5 cm, 36.4 x 36.4 x 2"  
incl. wheels - roues - wielen







ANTEGO

UFANT FRAME - STRUCTURE



		300 x 200	300 x 300	ø 350
	A01 white		A03 linen	choose category of fabric
	A12 alu teal		A14 lava	
	A30 anthracite		A32 black	

UCANT CANOPY - TOILE - DOEK







CATEGORY 1

	C001 natural		C010 latte	€ 1.595	€ 1.995	€ 1.995
	C024 clay <b>NEW</b>		C101 cloud			
	C208 black		C211 steel			
	C304 walnut					

CATEGORY 2

	C019 tofu <b>NEW</b>		C023 heather <b>NEW</b>	/	€ 2.295	/
---	----------------------	---	-------------------------	---	---------	---

CATEGORY 3

	C003 pearl		C011 cotton	/	€ 2.595	/
	C022 Nile <b>NEW</b>		C207 onyx			
	C210 pitch		C305 umber			

CATEGORY 3

ON DEMAND	see overview fabrics on p. 81 - minimum 6 umbrellas / colour	/	€ 2.595	/
-----------	--	---	---------	---

CATEGORY 2

see overview fabrics on p. 82	€ 1.995	€ 2.295	€ 2.295
-------------------------------	---------	---------	---------

UB BASE - PARASOLVOET

BASES WITH OPTIONAL WHEELS

	ANT-120-NW-G04 silk grey granite	€ 545
OPTIONAL	ANT-EW60-G04 silk grey granite tiles - tuiles - tegels (p.44)	€ 595

	ANT-120-NW-G32 black granite	€ 695
---	------------------------------	-------

	ANT-125-NW-G13 Egyptian sandstone	€ 895
---	-----------------------------------	-------

	ANT-125-NW-B01 concrete white	€ 695
	ANT-125-NW-B03 concrete linen	
	ANT-125-NW-B30 concrete anthracite	

OPTIONAL	UABTEN-SP037-SET set of 4 stainless steel wheels	€ 199
	UABANT-SP037(A)-SET set of 4 synthetic wheels	€ 175

BASES WITH WHEELS INCLUDED

	ANT-125-S01 powder coated steel white <b>NEW</b>	€ 1.595
	ANT-125-S03 powder coated steel linen <b>NEW</b>	
	ANT-125-S30 powder coated steel anthracite <b>NEW</b>	
	ANT-125-S32 powder coated steel black <b>NEW</b>	

IGB / OGB

IGB-FP-5G-MEDIUM in ground base - ancre de sol - grondanker	€ 245
OGB-FP-5G-MEDIUM on ground base - plaque de fixation - bevestigingsplaat	€ 225

UP COVER - HOUSSE - HOES

ANT-M-X75 grey	€ 75
ANT-M-X74 gris nature	€ 125

UA ACCESSORIES - ACCESSOIRES

LUN-LED02 Luna LED light - lumière - verlichting	€ 175
--	-------

# LIMA

UPDATED

Free pole frame, powder coated aluminium.  
 Mât déporté, aluminium thermolaqué.  
 Vrijhangende parasol, gepoederlakt aluminium.

Canopy is weatherproof and colour resistant.  
 Toile est résistant aux intempéries et aux couleurs.  
 Doek is weerbestendig en kleurvast.

Tilt in height, rotation 360°.  
 Inclinable à gauche et à droite, rotation de 360°.  
 Kantelen in de hoogte, 360° rotatie.

max. 45 km/h, 28 mph

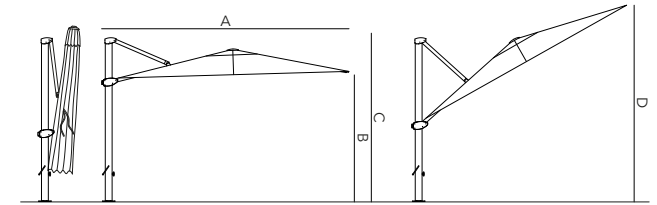

	400 X 300 CM	400 X 400 CM
	46 kg - 101.4 lbs nett excl. base - voet 50 kg - 110.2 lbs gross excl. base - voet	54 kg - 119 lbs nett excl. base - voet 58 kg - 127.9 lbs gross excl. base - voet
	300 x 50 x 28.5 cm, 0.4 cbm excl. base - voet	316 x 50 x 28.5 cm, 0.4 cbm excl. base - voet
A	364 cm - 106.7"	464 cm - 182.7"
B	240 cm - 94.5"	240 cm - 94.5"
C	290 cm - 114.2"	290 cm - 114.2"
D	384 cm - 151.2"	364 cm - 143.3"

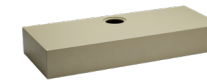

UBLIM-HAL  
LIMA HALF BASE

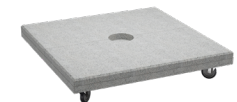

UBLIM-INF  
LIMA GRANITE BASE

## LIMA

## UFLIM FRAME - STRUCTURE







400 x 300 400 x 400

	A01 white		A03 linen	choose category of fabric	choose category of fabric
	A30 anthracite		A32 black		

## UCLIM CANOPY - TOILE - DOEK

## CATEGORY 1

400 x 300 400 x 400

	C001 natural		C010 latte	€ 2.695	€ 2.995
	C024 clay <b>NEW</b>		C101 cloud		
	C208 black		C211 steel		
	C304 walnut				

## CATEGORY 2

	C019 tofu <b>NEW</b>		C023 heather <b>NEW</b>	/	€ 3.395
---	----------------------	---	-------------------------	---	---------

## CATEGORY 3

	C003 pearl		C011 cotton	/	€ 3.795
	C022 Nile <b>NEW</b>		C207 onyx		
	C210 pitch		C305 umber		

## CATEGORY 3

see overview fabrics on p. 81 - minimum 3 umbrellas / colour	/	€ 3.795
--	---	---------

## CATEGORY 2

see overview fabrics on p. 82	€ 2.895	€ 3.395
-------------------------------	---------	---------

## UB BASE - PARASOLVOET

## BASES WITH WHEELS INCLUDED

	LIM-silk grey granite <b>NEW</b>	€ 1.425
---	----------------------------------	---------

## BASES WITHOUT WHEELS

	LIM-HAL-A01 half base white <b>NEW</b>	€ 1.495
	LIM-HAL-A03 half base linen <b>NEW</b>	
	LIM-HAL-A30 half base anthracite <b>NEW</b>	
	LIM-HAL-A32 half base black <b>NEW</b>	

## IGB / OGB

IGB-FP-LARGE in ground base - ancre de sol - grondanker	€ 265
OGB-FP-LARGE on ground base - plaque de fixation - bevestigingsplaat	€ 295

## UP COVER - HOUSSE - HOES

LIM-LX75 grey	€ 145
---------------	-------

## UA ACCESSORIES - ACCESSOIRES

LUN-LED02 Luna LED light - lumière - verlichting	€ 175
--	-------

FAST STOCK

ON DEMAND

# TULI

## UPDATED

Mid pole frame, powder coated aluminium with locking pins & tilt function.  
 Mât central, aluminium thermolaqué avec goupilles de blocage & système d'inclinaison.  
 Middenstam parasol, gepoederlakt aluminium met vergrendelingspinnen & kantelfunctie

Flexible rib ends in fiber glass.  
 Côtes flexibles en fibre de verre.  
 Flexibele baleinen van glasvezel.

Diameter of the pole: 38 mm, 1.5".  
 Diamètre du mât: 38 mm, 1.5".  
 Diameter van de mast: 38 mm, 1.5".

max. 65 km/h, 40.4 mph

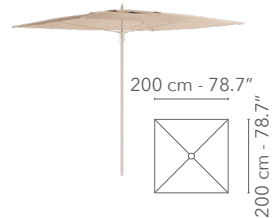
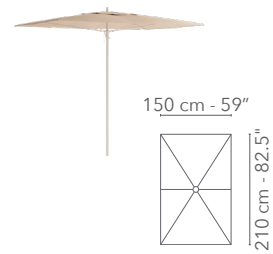
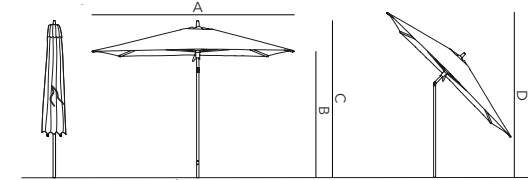

	150 X 210 CM	200 X 200 CM	240 X 240 CM	ø 270 CM
	5 kg - lbs nett excl. base - voet 6.2 kg - lbs gross excl. base - voet	5 kg - lbs nett excl. base - voet 7 kg - lbs gross excl. base - voet	5.4 kg - lbs nett excl. base - voet 7.2 kg - lbs gross excl. base - voet	5.7 kg - lbs nett excl. base - voet 7 kg - lbs gross excl. base - voet
	237 x 14 x 14 cm, cbm excl. base - voet	237 x 14 x 14 cm, cbm excl. base - voet	237 x 14 x 14 cm, 0.04 cbm excl. base - voet	237 x 17 x 17 cm, 0.cbm excl. base - voet
A	150 cm - 59"	200 cm - 78.7"	240 cm - 94.5"	270 cm - 106.3"
B	205 cm - 80.7"	195 cm - 76.8"	196 cm - 77.2"	199 cm - 78.3"
C	230 cm - 90.6"	230 cm - 90.6"	230 cm - 90.6"	230 cm - 90.6"
D	245 cm - 96.5"	249 cm - 98"	259 cm - 102"	270 cm - 106.3"



UBTUL-50  
 TULI ROUND  
 CONCRETE - BETON

50 kg, 110.2 lbs  
 ø 60 x 9 cm  
 ø 23.6 x 3.5"  
 incl. wheels - roues - wielen  
 B01 white, B03 linen, B32 black



TULI WITH TILT

UMTUL FRAME & CANOPY - STRUCTURE & TOILE - FRAME & DOEK

150 x 210    200 x 200    240 x 240    ø 270

CATEGORY 1

	CLASSICS			150 x 210	200 x 200	240 x 240	ø 270
		A01C101 white & cloud		€ 445	€ 445	€ 495	€ 495
		A03C010 linen & latte					
		A12C001 alu teak & natural					
		A32C208 black & black					
	SPECIALS	A01C001Y04 white & natural with sisal piping <b>NEW</b>		/	/	€ 595	€ 595
		A01C447Y01 white & kale with bone piping <b>NEW</b>					
		A01C448Y01 white & spa with bone piping <b>NEW</b>					
		A01C449Y01 white & admiral with bone piping <b>NEW</b>					

UB BASE - PARASOLVOET

BASES WITH WHEELS INCLUDED

	TUL-50-B01 tuli round white	€ 295
	TUL-50-B03 tuli round linen <b>NEW</b>	
	TUL-50-B32 tuli round black	
	ELB-44-S01 elba medium white hot dip galvanized	€ 745
	ELB-44-S03 elba medium linen hot dip galvanized	
	ELB-44-S31 elba medium charcoal hot dip galvanized	

BASES WITH OPTIONAL WHEELS

	LUC-60-NT-B01 lucca heavy (no tube) white	€ 225
	LUC-60-NT-B06 lucca heavy (no tube) hazel	
	LUC-60-NT-B30 lucca heavy (no tube) anthracite	
	UABLUC-25/55-A01SP036 lucca base tube 25-55mm white	incl.
	UABLUC-25/55-A06SP036 lucca base tube 25-55mm hazel	
	UABLUC-25/55-A30SP036 lucca base tube 25-55mm anthracite	
OPTIONAL	UALUC-WHE.60 lucca heavy wheels - roues - wielen (p.39)	€ 95

IGB / OGB

IGB-MP-SM in ground base - ancre de sol - grondanker*	€ 245
BS-MP-SMALL beach spike	€ 55

\*Locking only possible under slider. - Verouillage uniquement sous le glisseur. - Vergrendeling enkel mogelijk onder de slider

UP COVER - HOUSSE - HOES

UMB-S-X75 grey	€ 75
----------------	------

UA ACCESSORIES - ACCESSOIRES

LUN-LED02 Luna LED light - lumière - verlichting	€ 175
--	-------

# AMALFI

Mid pole frame, powder coated aluminium.  
Mât central, aluminium thermolaqué.  
Middenstam parasol, gepoederlakt aluminium.

Canopy is weatherproof and colour resistant.  
Toile est résistant aux intempéries et aux couleurs.  
Doek is weerbestendig en kleurvast.

Diameter of the pole:  $\varnothing$  40 mm, 1.6".  
Diamètre du mât :  $\varnothing$  40 mm, 1.6".  
Diameter van de mast:  $\varnothing$  40 mm, 1.6".

max. 39 km/h, 24 mph

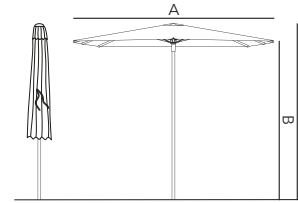
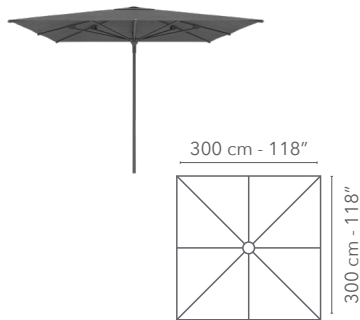

	250 X 250 CM	300 X 300 CM	$\varnothing$ 300 CM
	15 kg - 33.1 lbs nett excl. base - voet 18 kg - 39.7 lbs gross excl. base - voet	16 kg - 35.2 lbs nett excl. base - voet 17.8 kg - 39.2 lbs gross excl. base - voet	16 kg - 35.2 lbs nett excl. base - voet 17.8 kg - 15.4 lbs gross excl. base - voet
	245 x 23 x 25 cm, 0.13 cbm excl. base - voet	245 x 23 x 23 cm, 0.13 cbm excl. base - voet	245 x 23 x 24 cm, 0.14 cbm excl. base - voet
	250 cm - 98.4"	300 cm - 118.1"	300 cm - 118.1"
B	216 cm - 85"	216 cm - 85"	216 cm - 85"
C	250 cm - 98.4"	250 cm - 98.4"	250 cm - 98.4"



**UBELB-44**  
ELBA MEDIUM  
STEEL - ACIER - STAAL

44 kg, 97 lbs  
54.5 x 54.5 x 1.8 cm,  
21.5 x 21.5 x 0.7"  
incl. wheels - roues - wielen  
S01 white, S03 linen, S31 charcoal







**UBLUC-60-NT**  
UABLUC-25/55  
LUCCA HEAVY  
CONCRETE - BETON

60 kg, 132.3 lbs  
59 x 59 x 8 cm  
23.2 x 23.2 x 3.1"  
B01 white, B06 hazel, B30 anthracite  
optional: wheels - roues - wielen (p.39)







AMALFI

UFAMA FRAME - STRUCTURE

		250 x 250	300 x 300	ø 300
	A01 white		A03 linen	choose category of fabric
	A12 alu teal		A30 anthracite	
	A32 black			

UCAMA CANOPY - TOILE - DOEK

CATEGORY 1

	C001 natural		C010 latte	€ 1.195	€ 1.495	€ 1.195
	C024 clay <b>NEW</b>		C101 cloud			
	C208 black		C211 steel			
	C304 walnut					

CATEGORY 2

	C019 tofu <b>NEW</b>		C023 heather <b>NEW</b>	/	€ 1.795	/
---	----------------------	---	-------------------------	---	---------	---

CATEGORY 3

	C003 pearl		C011 cotton	/	€ 2.095	/
	C022 Nile <b>NEW</b>		C207 onyx			
	C210 pitch		C305 umber			

CATEGORY 3

ON DEMAND	see overview fabrics on p. 81 - minimum 6 umbrellas / colour	/	€ 2.095	/
-----------	--	---	---------	---







CATEGORY 2

see overview fabrics on p. 82	€ 1.595	€ 1.795	€ 1.595
-------------------------------	---------	---------	---------

UB BASE - PARASOLVOET

BASES WITH WHEELS INCLUDED

	ELB-44-S01 elba medium white hot dip galvanized	€ 745
	ELB-44-S03 elba medium linen hot dip galvanized	
	ELB-44-S31 elba medium charcoal hot dip galvanized	

	LUC-60-NT-B01 lucca heavy (no tube) white	€ 225
	LUC-60-NT-B06 lucca heavy (no tube) hazel	
	LUC-60-NT-B30 lucca heavy (no tube) anthracite	
	UABLUC-25/55-A01SP036 lucca base tube 25-55mm white	incl.
	UABLUC-25/55-A06SP036 lucca base tube 25-55mm hazel	
	UABLUC-25/55-A30SP036 lucca base tube 25-55mm anthracite	
OPTIONAL	UALUC-WHE.60 lucca heavy wheels - roues - wielen (p.39)	€ 95

IGB

IGB-MP-SM in ground base - ancre de sol - grondanker	€ 245
--	-------

UP COVER - HOUSSE - HOES

AMA-M-X75	€ 75
-----------	------

UA ACCESSORIES - ACCESSOIRES

LUN-LED02 Luna LED light - lumière - verlichting	€ 175
--	-------

# MACRAMÉ

NEW

Diameter of the pole:  $\varnothing$  48 mm, 1.9".  
 Diamètre du mât :  $\varnothing$  48 mm, 1.9".  
 Diameter van de mast:  $\varnothing$  48 mm, 1.9".

Mid pole frame, teak AB grade.  
 Mât central, teak qualité AB.  
 Middenstam parasol, teak AB kwaliteit.

Handknotted canopy, 100% cotton.  
 Toile nouée à la main, 100% coton.  
 Handgeknoopt doek, 100% katoen.

max. 17 km/h, 10.6 mph

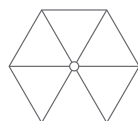
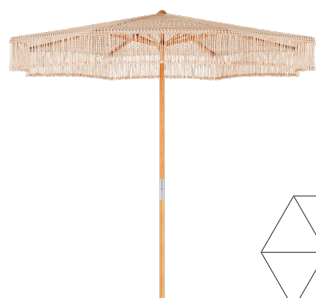

250 cm - 98.4"

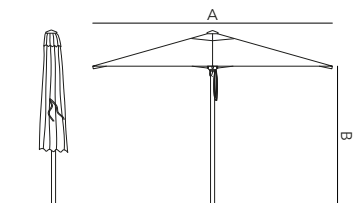

$\varnothing$  250 CM

	23 kg - 50.7 lbs nett excl. base - voet 24 kg - 52.9 lbs gross excl. base - voet
	167 x 29 x 29 cm, 0.14 cbm excl. base - voet
A	250 cm, 98.4"
B	210 cm, 65.7"
C	235 cm, 92.5"



**UBELB-84**  
**ELBA HEAVY**  
 STEEL - ACIER - STAAL





84 kg, 185.2 lbs  
 75.5 x 75.5 x 1.8 cm  
 29.7 x 29.7 x 0.7"  
 incl. wheels - roues - wielen  
 S01 white, S31 charcoal

**UBLUC-60**  
**LUCCA HEAVY**  
 CONCRETE - BETON

60 kg, 132.3 lbs  
 59 x 59 x 8 cm  
 23.2 x 23.2 x 3.1"  
 B01 white, B06 hazel, B30 anthracite  
 optional: wheels - roues - wielen (p.39)







## MACRAMÉ fully assembled (excl. base)

UMMAC FRAME & CANOPY - STRUCTURE & TOILE - FRAME & DOEK ø 250

		W62MR03 teak & macramé natural	€ 1.295
		W62MR13 teak & macramé sand	

UB BASE - VOET

BASES WITH OPTIONAL WHEELS

	LUC-60-NT-B01 lucca heavy white	€ 225
	LUC-60-NT-B06 lucca heavy hazel	
	LUC-60-NT-B30 lucca heavy anthracite	
	UABLUC61-A01SP036 lucca base tube 61mm white	incl.
	UABLUC61-A06SP036 lucca base tube 61mm hazel	
	UABLUC61-A30SP036 lucca base tube 61mm anthracite	
OPTIONAL	UALUC-WHE.60 lucca light wheels - roues - wielen (p.39)	€ 95

BASES WITH WHEELS

	ELB-84-S01 elba heavy white hot dip galvanized	€ 995
	ELB-84-S03 elba heavy linen hot dip galvanized	
	ELB-84-S31 elba heavy charcoal hot dip galvanized	

IGB

IGB-MP-SMALL in ground base - grondanker - ancre de sol	€ 245
---	-------

UP COVER - HOUSSE - HOES

UMB-S-X75 grey	€ 75
----------------	------

# CUBA

Mid pole frame, eucalyptus.  
Mât central, eucalyptus.  
Middenstam parasol, eucalyptus.

Canopy is weatherproof and colour resistant.  
Toile est résistant aux intempéries et aux couleurs.  
Doek is weerbestendig en kleurvast.

Diameter of the pole:  $\varnothing$  61 mm, 2.4".  
Diamètre du mât :  $\varnothing$  61 mm, 2.4".  
Diameter van de mast:  $\varnothing$  61 mm, 2.4".

max. 39 km/h, 24.2 mph



300 x 300 cm &  $\varnothing$  350 cm

300 cm - 118.1"

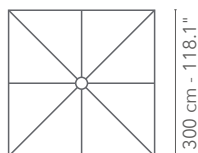

300 cm - 118.1"

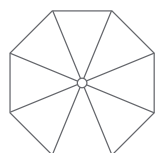

350 cm - 137.8"

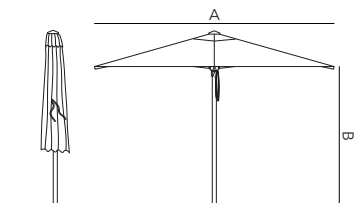

	300 X 300 CM	$\varnothing$ 350 CM
	26 kg - 57.3 lbs nett excl. base - voet 28 kg - 61.7 lbs gross excl. base - voet	28 kg - 41.9 lbs nett excl. base - voet 30 kg - 66 lbs gross excl. base - voet
	271 x 32 x 32 cm, 0.28 cbm excl. base - voet	265 x 32 x 32 cm, 0.27 cbm excl. base - voet
A	300 cm - 118.1"	350 cm - 137.8"
B	265 cm - 104.3"	234 cm - 92.1"
C	300 cm - 118.1"	265 cm - 104.3"



**UBELB-84**  
ELBA HEAVY  
STEEL - ACIER - STAAL

84 kg, 185.2 lbs  
75.5 x 75.5 x 1.8 cm  
29.7 x 29.7 x 0.7"  
incl. wheels - roues - wielen  
S01 white, S31 charcoal

**UBLUC-60**  
LUCCA HEAVY  
CONCRETE - BETON

60 kg, 132.3 lbs  
59 x 59 x 8 cm  
23.2 x 23.2 x 3.1"  
B01 white, B06 hazel, B30 anthracite  
optional: wheels - roues - wielen (p.39)

CUBA











UFCUB FRAME - STRUCTURE

300 x 300 ø 350

	W60 eucalyptus	choose category of fabric	choose category of fabric
---	----------------	---------------------------	---------------------------

UCCUB CANOPY - TOILE - DOEK

CATEGORY 1

	C001 natural		C010 latte	€ 1.895	€ 1.895
	C101 cloud		C106 gris nature		
	C204 night		C208 black		
	C211 steel		C212 gasoline		
	C301 taupe		C304 walnut		

CATEGORY 2

	C019 tofu <b>NEW</b>		C023 heather <b>NEW</b>	€ 2.195	€ 2.195
---	----------------------	---	-------------------------	---------	---------

CATEGORY 3

	C003 pearl		C011 cotton	€ 2.495	€ 2.495
	C022 nile <b>NEW</b>		C207 onyx		
	C210 pitch		C305 umber		

CATEGORY 3







see overview fabrics on p. 81 - minimum 3 umbrellas / colour	€ 2.495	€ 2.495
--	---------	---------

CATEGORY 2

see overview fabrics on p. 82	€ 2.195	€ 2.195
-------------------------------	---------	---------

UB BASE - VOET

BASES WITH OPTIONAL WHEELS

	LUC-60-NT-B01 lucca heavy white	€ 225
	LUC-60-NT-B06 lucca heavy hazel	
	LUC-60-NT-B30 lucca heavy anthracite	
	UABLUC61-A01SP036 lucca base tube 61mm white	incl.
	UABLUC61-A06SP036 lucca base tube 61mm hazel	
	UABLUC61-A30SP036 lucca base tube 61mm anthracite	
OPTIONAL	UALUC-WHE.60 lucca light wheels - roues - wielen (p.39)	€ 95

BASES WITH WHEELS

	ELB-84-S01 elba heavy white hot dip galvanized	€ 995
	ELB-84-S03 elba heavy linen hot dip galvanized	
	ELB-84-S31 elba heavy charcoal hot dip galvanized	

IGB / OGB

IGB-MP-LARGE in ground base - ancre de sol - grondanker	€ 245
FFP-MP-LARGE on ground base - plaque de fixation - bevestigingsplaat	€ 295

UP COVER - HOUSSE - HOES

CUB-M	incl.
-------	-------

FAST STOCK

ON DEMAND

# MOOREA

Mid pole frame, teak scratched.  
Mât central, teck avec finition rayée  
Middenstam parasol, geborstelde teak.

Canopy is weatherproof and colour resistant.  
Toile est résistant aux intempéries et aux couleurs.  
Doek is weerbestendig en kleurvast.

Diameter of the pole: ø 61 mm, 2.4".  
Diamètre du mât : ø 61 mm, 2.4".  
Diameter van de mast: ø 61 mm, 2.4".

Frame & canopy are supplied seperately to avoid stains.  
Structure & toile sont fournis séparément pour éviter les taches.  
Frame & doek worden apart geleverd om vlekken te voorkomen.

max. 39 km/h, 24.2 mph

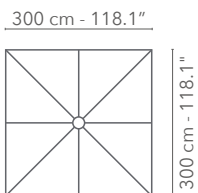

300 x 300 cm

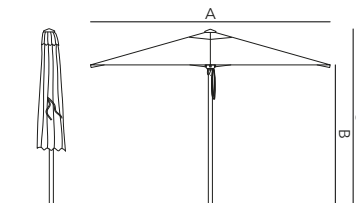

300 X 300 CM

	24 kg - 52.9 lbs nett excl. base - voet 26 kg - 57.3 lbs gross excl. base - voet
	271 x 32 x 32 cm, 0.28 cbm excl. base - voet
A	300 cm - 118.1"
B	238 cm - 93.7"
C	272 cm - 107.1"



**UBELB-84**  
ELBA HEAVY  
STEEL - ACIER - STAAL

84 kg, 185.2 lbs  
75.5 x 75.5 x 1.8 cm  
29.7 x 29.7 x 0.7"  
incl. wheels - roues - wielen  
S01 white, S31 charcoal



**UBLUC-60**  
LUCCA HEAVY  
CONCRETE - BETON

60 kg, 132.3 lbs  
59 x 59 x 8 cm  
23.2 x 23.2 x 3.1"  
B01 white, B06 hazel, B30 anthracite  
optional: wheels - roues - wielen (p.39)



## MOOREA

## UFMOO FRAME - STRUCTURE

300 x 300

	W63 teak scratched	choose category of fabric
---	--------------------	---------------------------

## UCCUB CANOPY - TOILE - DOEK







## CATEGORY 1

	C001 natural		C010 latte	€ 2.895
	C101 cloud		C106 gris nature	
	C204 night		C208 black	
	C211 steel		C212 gasoline	
	C301 taupe		C304 walnut	

## CATEGORY 2

	C019 tofu <b>NEW</b>		C023 heather <b>NEW</b>	€ 3.195
---	----------------------	---	-------------------------	---------

## CATEGORY 3

	C003 pearl		C011 cotton	€ 3.495
	C022 Nile <b>NEW</b>		C207 onyx	
	C210 pitch		C305 umber	

## CATEGORY 3







see overview fabrics on p. 81 - minimum 3 umbrellas / colour	€ 3.495
--	---------

## CATEGORY 2

see overview fabrics on p. 82	€ 3.195
-------------------------------	---------

## UB BASE - VOET

## BASES WITH OPTIONAL WHEELS

	LUC-60-B01 lucca heavy white	€ 225
	LUC-60-B06 lucca heavy hazel	
	LUC-60-B30 lucca heavy anthracite	
	UABLUC61-A01SP036 lucca base tube 61mm white	incl.
	UABLUC61-A06SP036 lucca base tube 61mm hazel	
	UABLUC61-A30SP036 lucca base tube 61mm anthracite	
OPTIONAL	UALUC-WHE.60 lucca light wheels - roues - wielen (p.39)	€ 95

## BASES WITH WHEELS

	ELB-84-S01 elba heavy white hot dip galvanized	€ 995
	ELB-84-S03 elba heavy linen hot dip galvanized	
	ELB-84-S31 elba heavy charcoal hot dip galvanized	

## IGB / OGB

IGB-MP-LARGE in ground base - ancre de sol - grondanker	€ 245
FFP-MP-LARGE on ground base - plaque de fixation - bevestigingsplaat	€ 295

## UP COVER - HOUSSE - HOES

CUB-M	incl.
-------	-------

FAST STOCK

ON DEMAND

# ATTITUDE BASES - PARASOLVOETEN

## AZORE BASE silk grey granite

		<b>UBAZO-125-NW</b> silk grey granite		<b>G04</b> light grey granite, bush hammered granit gris clair bouchardé lichtgrijze graniet, gebouchardeerd	€ 465
OPTIONAL		<b>UBAZO-EW60</b> 2 half tiles 2 demi-tuiles 2 halve tegels		<b>G04</b> light grey granite, bush hammered granit gris clair bouchardé lichtgrijze graniet, gebouchardeerd	€ 495
		<b>UABTEN-SP037-SET</b>		set of 4 stainless steel wheels	€ 199
		<b>UABANT-SP037(A)-SET</b>		set of 4 synthetic wheels	€ 175

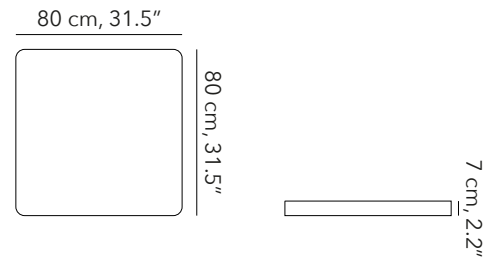

	base
nett weight	125 kg, 275.6 lbs
gross weight	128 kg, 282.2 lbs
	81 x 81 x 20 cm, 1 cbm

## ANTEGO BASE silk grey granite

		<b>UBANT-125-NW</b> silk grey granite		<b>G04</b> light grey granite, bush hammered granit gris clair bouchardé lichtgrijze graniet, gebouchardeerd	€ 545
OPTIONAL		<b>UBANT-EW60</b> 2 half tiles 2 demi-tuiles 2 halve tegels		<b>G04</b> light grey granite, bush hammered granit gris clair bouchardé lichtgrijze graniet, gebouchardeerd	€ 595
		<b>UABTEN-SP037-SET</b>		set of 4 stainless steel wheels	€ 199
		<b>UABANT-SP037(A)-SET</b>		set of 4 synthetic wheels	€ 175

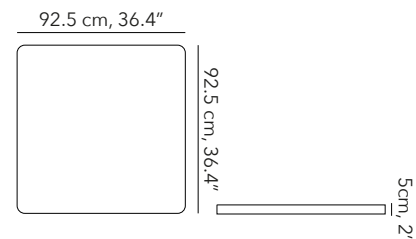



	base
nett weight	125 kg, 275.6 lbs
gross weight	128 kg, 282.2 lbs
	94 x 94 x 18 cm, cbm

# ATTITUDE BASES - PARASOLVOETEN

## ANTEGO BASE black granite

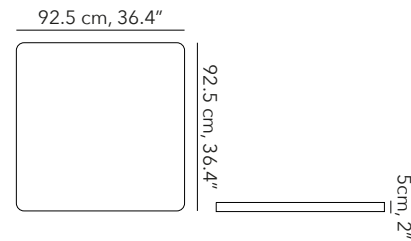
		UBANT-125-NW black granite		G32 black granite, bush hammered granit noir bouchardé zwart graniet, gebouchardeerd	€ 695
OPTIONAL		UABTEN-SP037-SET		set of 4 stainless steel wheels	€ 199
		UABANT-SP037(A)-SET		set of 4 synthetic wheels	€ 175



	base
nett weight	125 kg, 275.6 lbs
gross weight	128 kg, 282.2 lbs
	94 x 94 x 18 cm, cbm

## ANTEGO BASE sandstone



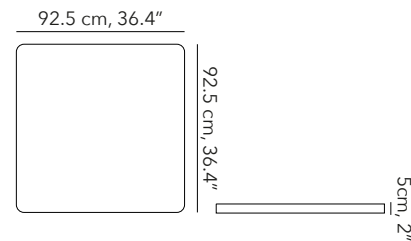



		UBANT-125-NW silk grey granite		G13 Egyptian sandstone with sandblasted finish	€ 895
OPTIONAL		UABTEN-SP037-SET		set of 4 stainless steel wheels	€ 199
		UABANT-SP037(A)-SET		set of 4 synthetic wheels	€ 175





	base
nett weight	125 kg, 275.6 lbs
gross weight	132 kg, 291 lbs
	94 x 94 x 18 cm, cbm

# ATTITUDE BASES - PARASOLVOETEN



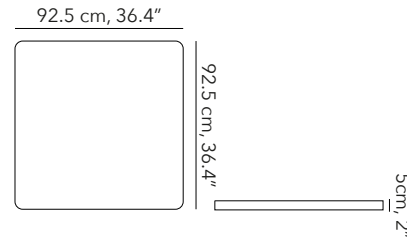



## ANTEGO BASE concrete

		UBANT-125-NW concrete	 B01 white	€ 695
			 B03 linen	
			 B30 anthracite	
OPTIONAL		UABTEN-SP037-SET	set of 4 stainless steel wheels	€ 199
		UABANT-SP037(A)-SET	set of 4 synthetic wheels	€ 175



	base
nett weight	125 kg, 275.6 lbs
gross weight	130 kg, 286.6 lbs
	x x cm, cbm





## ANTEGO BASE powder coated steel

		UBANT-125 powder coated steel	 S01 white	€ 1.595
			 S03 linen	
			 S30 anthracite	
			 S32 black	
			stainless steel chemical anchored	incl.

	base
nett weight	125 kg, 275.6 lbs
gross weight	130 kg, 286.6 lbs
	x x cm, cbm







# ATTITUDE BASES - PARASOLVOETEN

## LIMA BASE silk grey granite

	UBLIM-300 silk grey granite		G04 light grey granite, bush hammered granit gris clair bouchardé lichtgrijze graniet, gebouchardeerd	€ 1.425
				incl.

	base
nett weight	300 kg, 661.4 lbs
gross weight	305 kg, 672.4 lbs
	x x cm, cbm





## LIMA BASE half base

	UBLIM-HAL powder coated aluminium cover		A01 white	€ 1.495
			A03 linen	
			A30 anthracite	
			A32 black	
	base			incl.
	12 granite tiles of 20 kg		xxx granite	incl.

	base
nett weight	318 kg, 661.4 lbs
gross weight	320 kg, 705.5 lbs
	130 x 54 x 22.5 cm, 0.2 cbm





# ATTITUDE BASES - PARASOLVOETEN

## TULI BASE Tuli

	UBTUL-50 concrete	 B01 white	€ 295
		 B03 linen	
		 B32 black	
	UAB		incl.





	base
nett weight	50 kg, 110.2 lbs
gross weight	52 kg, 114.6 lbs
	74 x 67 x 13.5 cm, cbm

## ELBA MEDIUM Amalfi, Tuli

	UBELB-44 metallised & powder coated steel	 S01 white	€ 745
		 S03 linen	
		 S31 charcoal	
	UABELB-SP037		incl.

	base
nett weight	44 kg, 97 lbs
gross weight	46 kg, 101 lbs
	77.5 x 65 x 11 cm, cbm





## ELBA HEAVY Cuba, Moorea

	UBELB-44 metallised & powder coated steel	 S01 white	€ 995
		 S03 linen	
		 S31 charcoal	
	UABELB-SP037		incl.

	base
nett weight	84 kg, 185.2 lbs
gross weight	88 kg, 194 lbs
	99.5 x 86 x 12 cm, cbm









# ATTITUDE BASES - PARASOLVOETEN

## LUCCA LIGHT

		<b>UBLUC-35</b> concrete	 B01 white	€ 195
		adaptor rings: ø 18 - 50 mm	 B06 hazel	
	 B30 anthracite			
OPTIONAL		<b>UALUC-WHE.35</b>		€ 45

	base
nett weight	35 kg, 77.2 lbs
gross weight	40 kg, 88.2 lbs
	cm, cbm









## LUCCA HEAVY ø 61MM Cuba, Moorea

		UBLUC-60-NT concrete	 B01 white	€ 225
			 B06 hazel	
			 B30 anthracite	
OPTIONAL		UABLUC61	 A01SP036 white	incl.
			 A06SP036 hazel	
			 A30SP036 anthracite	
		UALUC-WHE.60		€ 95

	base
nett weight	60 kg, 132.3 lbs
gross weight	65 kg, 143.3 lbs
	cm, cbm

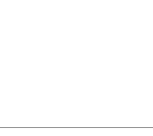
# ATTITUDE BASES - PARASOLVOETEN

## LUCCA HEAVY ø 25-55MM Amalfi, Tuli

	UBLUC-60-NT concrete	 B01 white	€ 225
		 B06 hazel	
		 B30 anthracite	
	UABLUC25/55	 A01SP036 white	incl.
		 A06SP036 hazel	
		 A30SP036 anthracite	
<b>OPTIONAL</b>		UALUC-WHE.60	€ 95

	base
nett weight	60 kg, 132.3 lbs
gross weight	65 kg, 143.3 lbs
	cm, cbm



# ATTITUDE BASES - PARASOLVOETEN

## IN GROUND BASE - ANCRE DE SOL GRONDANKER

### UBBS-MP-SMALL MID POLE SMALL Tuli

	beach spike aluminium	€ 49
---	--------------------------	------

### UBIGB-MP-SM MID POLE SMALL MEDIUM Amalfi, Tuli

	aluminium	€ 245
---	-----------	-------

### UBIGB-MP-LARGE MID POLE LARGE Cuba, Moorea

	6 kg, 13 lbs ø 7 x 67 cm, 2.8 x 26.4"	€ 245
	steel - acier - staal	

### UBIGB-AZO-4G-MEDIUM AZORE Azore

	5.7 kg, 12.6 lbs ø 21.5 x 51 cm, 8.5 x 20.1"	€ 245
	steel - acier - staal	

### UBIGB-FP-4G-MEDIUM ANTEGO Antego

	5.7 kg, 12.6 lbs ø 21.5 x 51 cm, 8.5 x 20.1"	€ 245
	steel - acier - staal	

### UBIGB-LIM-4G-LARGE LIMA Lima

	8.4 kg, 18.5 lbs ø 25 x 51 cm, 9.8 x 20.1"	€ 265
	steel - acier - staal	

## ON GROUND BASE - PLAQUES DU FIXATION BEVESTIGINGSPLAAT

### UBOGB-MP-LARGE MID POLE LARGE Cuba, Moorea

	8.4 kg, 18.5 lbs 30 x 30 x 44 cm, 11.8 x 11.8 x 17.3"	€ 295
	aluminium anodised - anodisé - geanodiseerd	

### UBOGB-AZO-4G-MEDIUM MID POLE MEDIUM Azore

	8 kg, 17.6 lbs ø 21.5 x 2.1 cm, 8.5 x 0.5"	€ 225
	steel - acier - staal	

### UBOGB-FP-4G-MEDIUM FREE POLE MEDIUM Antego

	8 kg, 17.6 lbs ø 21.5 x 2.1 cm, 8.5 x 0.5"	€ 225
	steel - acier - staal	

### UBOGB-LIM-4G-LARGE FREE POLE LARGE Lima

	8 kg, 17.6 lbs ø 21.5 x 1.2 cm, 8.5 x 0.5"	€ 295
	steel - acier - staal	



**OUTDOOR LIVING**  
DECORATION











Each pot is made with natural materials, combined with FRP. A robust, yet lightweight pot, UV and frost resistant.  
 Chaque pot est fait avec des matériaux naturels, combinés à du FRP. Un pot robuste, mais léger, résistant aux UV et au gel.  
 Elke pot is gemaakt met natuurlijke materialen, gecombineerd met FRP. Een robuuste, maar lichte pot, UV- en vorstbestendig.

## POTTERY - POTS - POTTEN



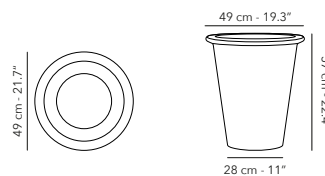

### TERRA CLASSIC LOW ø 48 x 57 cm

	DEPOTTERC48.L Terra classic low	 P03 sabbia	€ 295
		 P11 macchiato	
		 P32 nero	



nett weight	6 kg, 13.2 lbs
gross weight	8 kg, 17.6 lbs
	51 x 51 x 61 cm, 0.15 cbm

### TERRA CLASSIC MID ø 60 x 72 cm

	DEPOTTERC60.M Terra classic mid	 P03 sabbia	€ 495
		 P11 macchiato	
		 P32 nero	

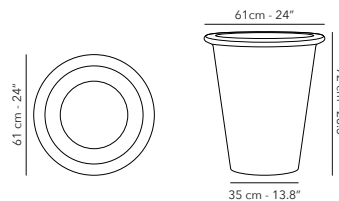

nett weight	9 kg, 19.8 lbs
gross weight	11 kg, 24.2 lbs
	63 x 63 x 76 cm, 0.3 cbm

### TERRA CLASSIC HIGH ø 150 x 180 cm



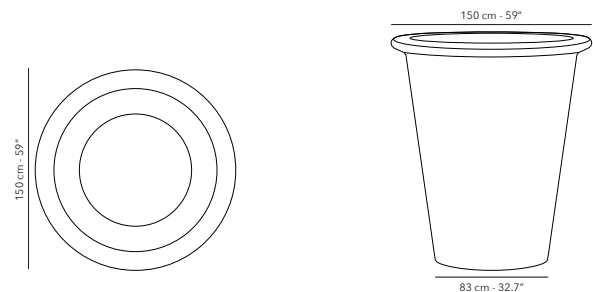

	DEPOTTERC150.H Terra classic high		€ 4.995
		P11 macchiato	





nett weight	70 kg, 154.3 lbs
gross weight	90 kg, 198 lbs
	157 x 157 x 192 cm, 4.7 cbm

# POTTERY - POTS - POTTEN



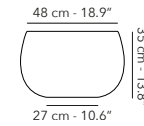

## TERRA BALLOON LOW ø 55 x 35 cm

	DEPOTTERB55.L Terra balloon low	 P03 sabbia	€ 215
		 P11 macchiato	
		 P32 nero	



nett weight	5 kg, 11 lbs
gross weight	6.5 kg, 14.3 lbs
	57 x 57 x 39 cm, 0.12 cbm



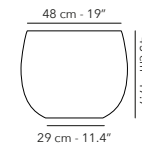

## TERRA BALLOON MID ø 55 x 45 cm

	DEPOTTERB55.M Terra balloon mid	 P03 sabbia	€ 255
		 P11 macchiato	
		 P32 nero	



nett weight	5.5 kg, 12.1 lbs
gross weight	7.5 kg, 16.5 lbs
	57 x 57 x 49 cm, 0.15 cbm

## TERRA BALLOON HIGH ø 55 x 56 cm

	DEPOTTERB55.H Terra balloon high	 P03 sabbia	€ 315
		 P11 macchiato	
		 P32 nero	

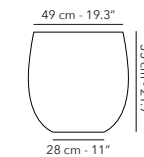

nett weight	6 kg, 13.2 lbs
gross weight	8 kg, 17.6 lbs
	57 x 57 x 59 cm, 0.19 cbm

# POTTERY - POTS - POTTEN

## TERRA CERCHIO SET 1 set of 2



DEPOTTERB-SET1  
DEPOTTERB91.H  
DEPOTTERB112.H

	P03 sabbia
	P11 macchiato
	P32 nero

€ 1.295

nett weight	31 kg, 68.3 lbs
gross weight	39 kg, 86 lbs
	114 x 114 x 70 cm, 0.9 cbm

## TERRA CERCHIO ø 91 x 56 cm



DEPOTTERB91.H  
Terra cerchio

	P03 sabbia
	P11 macchiato
	P32 nero

€ 595

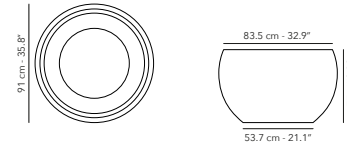

nett weight	12 kg, 26.5 lbs
gross weight	16 kg, 35.3 lbs
	93 x 93 x 59 cm, 0.5 cbm

## TERRA CERCHIO ø 112 x 67 cm



DEPOTTERB112.H  
Terra cerchio

	P03 sabbia
	P11 macchiato
	P32 nero

€ 895

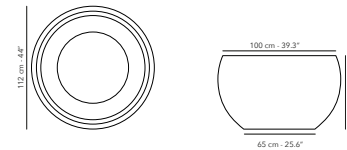

nett weight	19 kg, 41.9 lbs
gross weight	25 kg, 55 lbs
	114 x 114 x 70 cm, 0.9 cbm





# POTTERY - POTS - POTTEN

## TERRA DÔME SET 1 set of 3

	<b>DEPOTTERD-SET1</b> ø 45 x 45 cm ø 61 x 61 cm ø 83 x 82 cm	 P03 sabbia	€ 1.195
		 P11 macchiato	
		 P32 nero	

nett weight	32 kg, 70.5 lbs
gross weight	37 kg, 81.5 lbs
	85 x 85 x 87 cm, 0.62 cbm



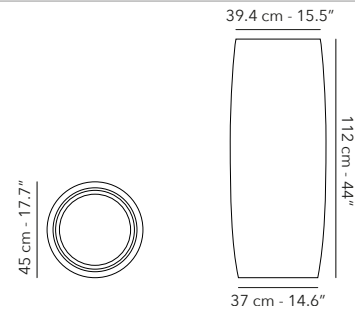

## TERRA ALTO MID ø 45 x 112 cm

	<b>DEPOTTERB55.M</b> Terra classic mid	 P03 sabbia	€ 395
		 P11 macchiato	
		 P32 nero	



nett weight	13.5 kg, 29.8 lbs
gross weight	16 kg, 35.2 lbs
	47 x 47 x 117 cm, 0.15 cbm

## TERRA ALTO HIGH ø 55 x 137 cm

	<b>DEPOTTERB55.H</b> Terra classic high	 P03 sabbia	€ 625
		 P11 macchiato	
		 P32 nero	

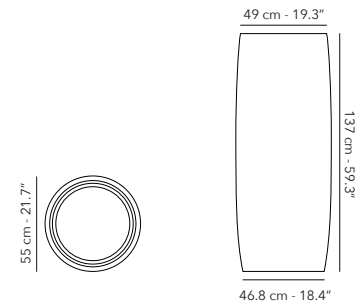

nett weight	19 kg, 41.9 lbs
gross weight	22 kg, 48.5 lbs
	57 x 57 x 142 cm, 0.19 cbm



# POTTERY - POTS - POTTEN

## TERRA CERCHIO SET 2 set of 3



**DEPOTTERB-SET2**  
 ø 55 x 35 cm  
 ø 73 x 46 cm  
 ø 91 x 56 cm



**P04** pietra

€ 1.245

NEW

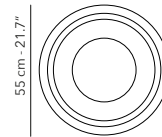

55 cm - 21.7"

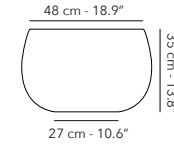

48 cm - 18.9"

35 cm - 13.8"

27 cm - 10.6"

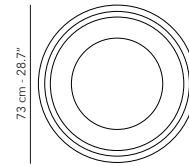

73 cm - 28.7"

67.8 cm - 26.7"



46 cm - 18.1"

43.4 cm - 17"

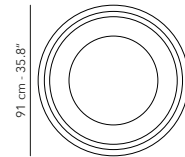

91 cm - 35.8"

83.5 cm - 32.9"

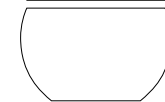

56 cm - 22"

53.7 cm - 21.1"

nett weight	25 kg, lbs
gross weight	32.5 kg, lbs
	93 x 93 x 60 cm, 0.5 cbm

# POTTERY - POTS - POTTEN

## CUMINO ALBERO SET 1 set of 3



DEPOTCUM-SET1  
DEPOTCUM52.L  
DEPOTCUM68.M  
DEPOTCUM88.H



P18 ruggine

€ 1.395

nett weight	39 kg, lbs
gross weight	44 kg, lbs
	90 x 90 x 108 cm, 0,9 cbm

## CUMINO ALBERO LOW ø 52 x 60 cm





DEPOTCUM52.L  
Cumino Albero Low

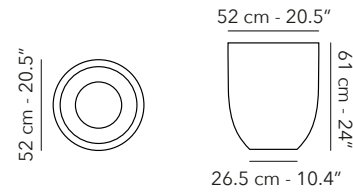

P18 ruggine

€ 275



nett weight	6 kg, 13.2 lbs
gross weight	8 kg, 17.6 lbs
	54 x 54 x 65 cm, 0.19cbm

## CUMINO ALBERO MID ø 68 x 80 cm





DEPOTCUM68.M  
Cumino Albero Mid

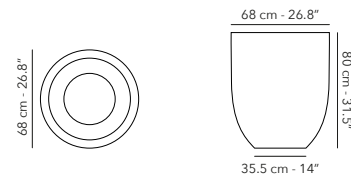

P18 ruggine

€ 525



nett weight	12 kg, 26.5 lbs
gross weight	14.5 kg, 32 lbs
	70 x 70 x 85 cm, 0.41 cbm

# POTTERY - POTS - POTTEN

## CUMINO ALBERO HIGH ø 88 x 102 cm





DEPOTCUM88.H  
Cumino Albero High

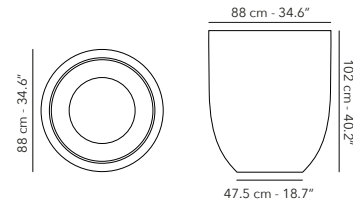

P18 ruggine

€ 895



nett weight	21 kg, 46.3 lbs
gross weight	23 kg, 50.7 lbs
	90 x 90 x 108 cm, 0.9 cbm

## CUMINO ALBERO SET 5 set of 3



DEPOTCUM-SET5  
ø 40 x 47 cm  
ø 52 x 61 cm  
ø 68 x 80 cm



P04 pietra

€ 995

NEW

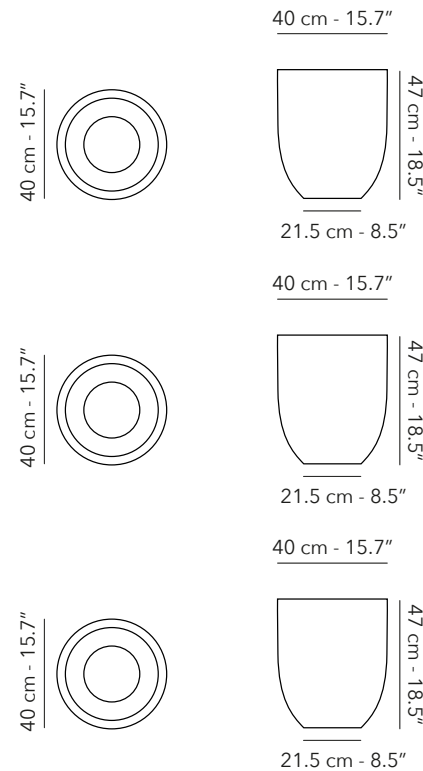

nett weight	21 kg, lbs
gross weight	27 kg, lbs
	70 x 70 x 84 cm, 0.4 cbm

# POTTERY - POTS - POTTEN

## CUMINO FIORE SET 2 set of 3



DEPOTCUM-SET2  
 ø 55 x 46 cm  
 ø 65 x 54 cm  
 ø 80 x 66 cm



P18 ruggine

€ 995



55 cm - 21.7"

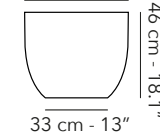

46 cm - 18.1"

33 cm - 13"

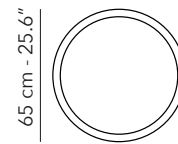

65 cm - 25.6"

65 cm - 25.6"

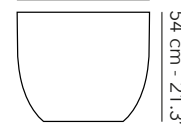

54 cm - 21.3"

36 cm - 14.2"

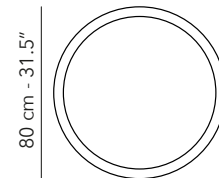

80 cm - 31.5"

80 cm - 31.5"

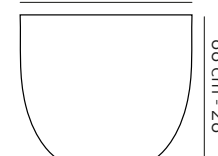

66 cm - 26"

48 cm - 19"

nett weight	30 kg, 66.1 lbs
gross weight	35.5 kg, 78.3 lbs
	82 x 82 x 71 cm, 0.5 cbm

# POTTERY - POTS - POTTEN

## CUMINO FIORE SET 4 set of 3

NEW



DEPOTCUM-SET4  
 ø 36 x 31 cm  
 ø 45 x 38 cm  
 ø 55 x 46 cm

 P04 pietra

€ 495

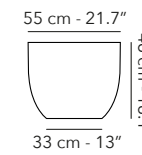
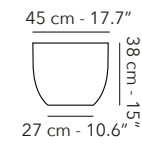
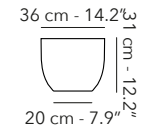

nett weight	10 kg, lbs
gross weight	14 kg, lbs
	57 x 57 x 50 cm, 0.2 cbm

# POTTERY - POTS - POTTEN

## CUMINO CALICE ø 120 x 130 cm





DEPOTCUMB120.H  
Cumino Calice

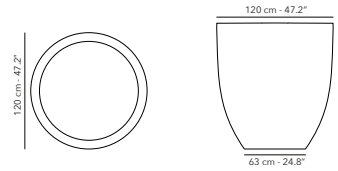

P01 panna

€ 3.995



nett weight	6 kg, 13.2 lbs
gross weight	8 kg, 17.6 lbs
	125 x 125 x 142cm, 2.2 cbm

## CUMINO FUNGO ø 114 x 54 cm





DEPOTCUM114.L  
Cumino Fungo

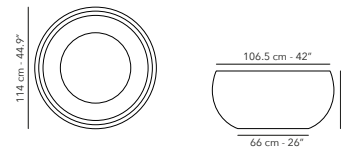

P01 panna

€ 995



nett weight	20 kg, 44.1 lbs
gross weight	23 kg, 50.7 lbs
	116 x 116 x 58 cm, 0.8 cbm

# POTTERY - POTS - POTTEN

## CUMINO CONICO SET 3 set of 3



DEPOTCUM-SET3  
DEPOTCUM46.L  
DEPOTCUM61.M  
DEPOTCUM84.H



P18 ruggine



P01 panna

€ 1.465

46 cm - 18.1"

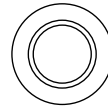

31 cm - 12.2"



46 cm - 18.1"

22 cm - 8.7"

61.5 cm - 24.2"

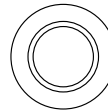

42.5 cm - 16.7"



61.5 cm - 24.2"

29 cm - 11.4"

84 cm - 33"

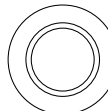

55.5 cm - 21.9"





82 cm - 32.3"

41 cm - 16.1"

nett weight	30 kg, 66.1 lbs
gross weight	35.5 kg, 78.3 lbs
	82 x 82 x 71 cm, 0.5 cbm

# POTTERY - POTS - POTTEN

## CARTELLO LOW ø 75 x 35 cm

	DEPOTCAR75.L Cartello low		P31 marone	€ 395
---	------------------------------	---	------------	-------

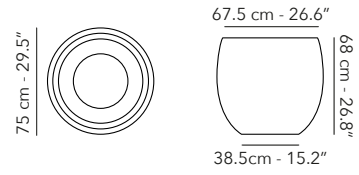

nett weight	8 kg, 17.6 lbs
gross weight	11 kg, 24.2 lbs
	78 x 78 x 39 cm, 0.23 cbm

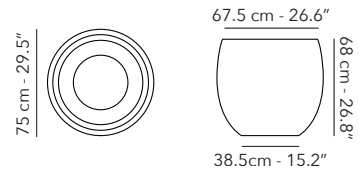

## CARTELLO HIGH ø 75 x 68 cm

	DEPOTCAR75.H Cartello high		P31 marone	€ 495
---	-------------------------------	---	------------	-------



nett weight	13 kg, 28.7 lbs
gross weight	11 kg, 24.3 lbs
	77 x 77 x 72 cm, 0.42 cbm

## CURVO SET 1 set of 3

	DEPOTCUR-SET1 ø 34 x 60 cm ø 44 x 80 cm ø 57 x 90 cm		P04 pietra <b>NEW</b>	€ 695
			P30 caffè	

nett weight	20 kg, lbs
gross weight	25 kg, lbs
	59 x 59 x 94 cm, 0.3 cbm



# POTTERY - POTS - POTTEN

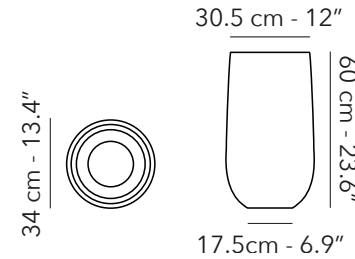

## CURVO LOW ø 32 x 60 cm

	DEPOTCUR32.L Curvo low	 P30 caffè	€ 145
---	---------------------------	---	-------



nett weight	3.5 kg, 7.7 lbs
gross weight	5.5 kg, 12 lbs
	36 x 36 x 64 cm, 0.08 cbm

## CURVO MID ø 45 x 80 cm

	DEPOTCUR45.M Curvo mid	 P30 caffè	€ 245
---	---------------------------	---	-------

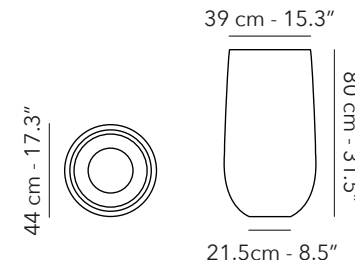

nett weight	7 kg, 15.4 lbs
gross weight	9 kg, 19.8 lbs
	46 x 46 x 84 cm, 0.17 cbm

## CURVO HIGH ø 55 x 90 cm

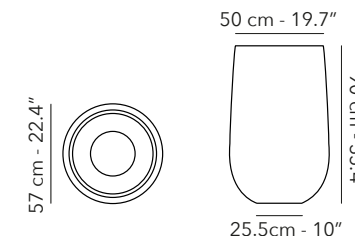

	DEPOTCUR55.H Curvo high	 P30 caffè	€ 395
---	----------------------------	---	-------





nett weight	9.5 kg, 20.9 lbs
gross weight	11.5 kg, 25.3 lbs
	59 x 59 x 94 cm, 0.32cbm

# POTTERY - POTS - POTTEN

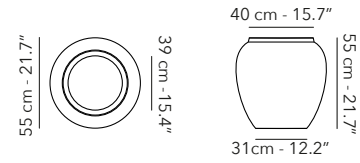

## ANTICO ANFORA ø 55 x 55 cm

	DEPOTANT55.L Antico Anfora	 P07 pistachio	€ 265
		 P12 bronzo	



nett weight	5.5 kg, 12.1 lbs
gross weight	8 kg, 17.6 lbs
	57 x 57 x 59 cm, 0.19 cbm

## ANTICO VASO ø 55 x 112 cm

	DEPOTANT55.H Antico Vaso	 P07 pistachio	€ 595
		 P12 bronzo	

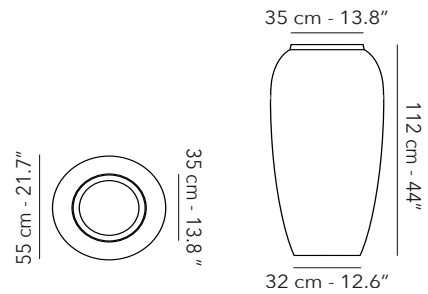



nett weight	14 kg, 30.9 lbs
gross weight	17 kg, 37.5 lbs
	57 x 57 x 116 cm, 0.37 cbm

# POTTERY - POTS - POTTEN

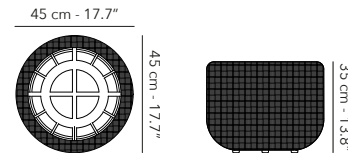

## TUGU SMALL ø 45 x 35 cm

	DEPOTTUG45.S Tugu small		F16 cottage	€ 395
---	----------------------------	---	-------------	-------



nett weight	3.8 kg, 8.4 lbs
gross weight	kg, lbs
	51 x 51 x 43 cm, cbm

## TUGU MEDIUM ø 65 x 50 cm

	DEPOTTUG65.M Tugu medium		F16 cottage	€ 645
---	-----------------------------	---	-------------	-------

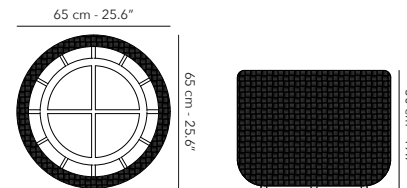

nett weight	7.3 kg, 16.1 lbs
gross weight	kg, lbs
	73 x 73 x 58 cm, cbm

## TUGU LARGE ø 85 x 70 cm

	DEPOTTUG85.L Tugu large		F16 cottage	€ 995
---	----------------------------	---	-------------	-------

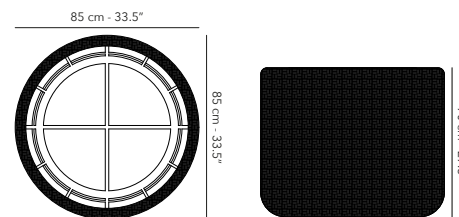

nett weight	11.5 kg, 25.4 lbs
gross weight	kg, lbs
	92 x 92 x 79 cm, cbm

# POTTERY

## CUBO SQUARE SMALL SET 1 set of 2

	<b>DEPOTCUB-SET1</b> 50 x 50 x 50 cm 60 x 60 x 60 cm	 P01 panna	€ 595
		 P33 ombra	

NEW

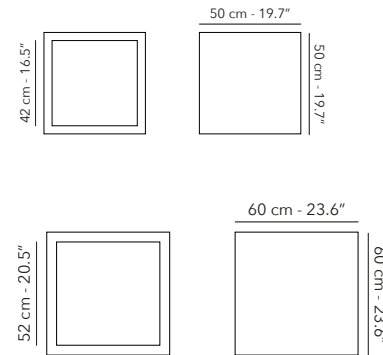



nett weight	21 kg, 46.3 lbs
gross weight	21.5 kg, 47.4 lbs
	57 x 57 x 50 cm, 0.2 cbm

## CUBO SQUARE LARGE SET 2 set of 2

	<b>DEPOTCUB-SET2</b> 75 x 75 x 75 cm 90 x 90 x 90 cm	 P01 panna	€ 1.845
		 P33 ombra	

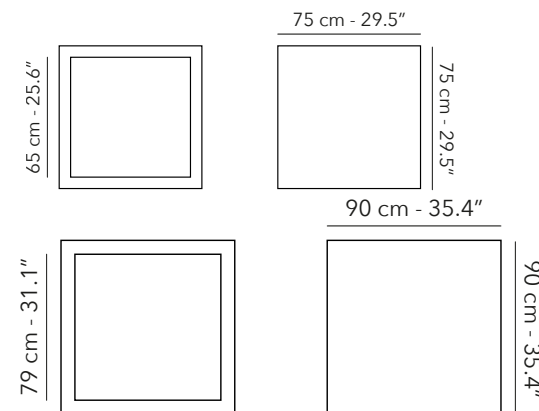

NEW





nett weight	59 kg, 130 lbs
gross weight	60 kg, 132 lbs
	x x cm, cbm

**CUBO DIVIDER SMALL** 90 x 45 x 90 cm

NEW

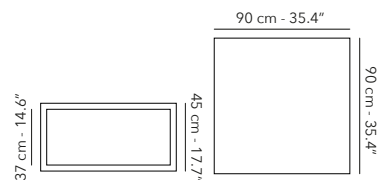

	DEPOTCUB-DIV-S Cubo divider small		P01 panna	€ 795
			P33 ombra	





nett weight	25 kg, 55 lbs
gross weight	26 kg, 57 lbs
	

**CUBO DIVIDER LARGE** 150 x 45 x 90 cm

NEW

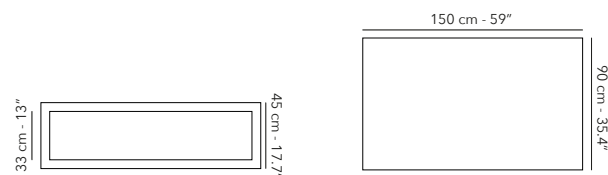
	DEPOTCUB-DIV-L Cubo divider large		P01 panna	€ 1.495
			P33 ombra	



nett weight	50 kg, 110 lbs
gross weight	51 kg, 112 lbs
	

# RUGS - TAPIS - TAPIJTEN







The representation of colours, dimensions and weights may differ from reality, as may variations when a product is handmade.

La reproduction des couleurs, les mesures et les poids peuvent différer de la réalité ainsi que des variations chaque fois qu'un produit est fait à la main.

De weergave van kleuren, afmetingen en gewichten kan afwijken van de werkelijkheid, evenals variaties wanneer een product handgemaakt is.

## WILSON

MADE IN BELGIUM

	DERUGWIL200X300 200 x 300 cm, 79 x 118"		D78 oyster	€ 995
			D79 greige	
	DERUGWIL250X350 250 x 350 cm, 98 x 138"		D78 oyster	€ 1.495
			D79 greige	
	DERUGWIL280X390 280 x 390 cm, 110 x 154"		D78 oyster	€ 1.845
			D79 greige	

polyester and high-quality Decolan yarn - polyester et fil Decolan de la plus haute qualité - polyester en hoogwaardige Decolan garen

## COCO







DERUGCOC300XR ø 300 cm, 118"		D72 camel	€ 1.495
DERUGCOC300X400 300 x 400 cm, 118 x 157"		D72 camel	€ 1.895
DERUGCOC400X600 400 x 600 cm, 157 x 236"		D72 camel	€ 3.745

hand braided polyester rope - corde en polyester, tressé à la main - handgevlochten polyester touw

Border with piping only along the width of the rug, no border on round carpets. - Bordure avec passepoil uniquement sur la largeur du tapis, pas de bordure sur les tapis ronds. - Rand met bies alleen op de breedte van het tapijt, geen biesrand bij ronde tapijten.

## YARA



DERUGYAR300XR ø 300 cm, 118"		D71 biscuit	€ 2.495
DERUGYAR250X350 250 x 350 cm, 98 x 138"		D71 biscuit	€ 2.995
DERUGYAR300X400 300 x 400 cm, 118 x 157"		D71 biscuit	€ 3.495
TAILORMADE Maximum width 3m, unlimited length possible		D71 biscuit	€ 295 /m <sup>2</sup>

PVC coated polyester - polyester enduit de PVC - polyester met PVC coating

# RUGS - TAPIS - TAPIJTEN

## NINO

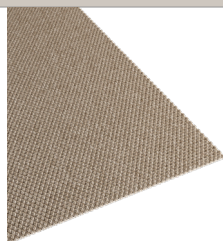

DERUGNIN300XR ø 300 cm, 118"		D76 beaver	€ 3.495
DERUGNIN250X350 250 x 350 cm, 98 x 138"		D76 beaver	€ 4.340
DERUGNIN300X400 300 x 400 cm, 118 x 157"		D76 beaver	€ 4.445
<b>TAILORMADE</b> Maximum width 3m, unlimited length possible		D76 beaver	€ 415 /m <sup>2</sup>

PVC coated polyester - polyester enduit de PVC - polyester met PVC coating

NEW

## IONA





DERUGION300XR ø 300 cm, 118"		D05 seal	€ 3.495
DERUGION250X350 250 x 350 cm, 98 x 138"		D05 seal	€ 4.340
DERUGION300X400 300 x 400 cm, 118 x 157"		D05 seal	€ 4.995
DERUGION400X500 400 x 500 cm, 157 x 197"		D05 seal	€ 7.995
<b>TAILORMADE</b> Maximum width 3m, unlimited length possible		D05 seal	€ 415 /m <sup>2</sup>

PVC coated polyester - polyester enduit de PVC - polyester met PVC coating

Border with piping only along the length of the rug, no border on round rugs. - Bordure avec passepoil uniquement sur la longueur du tapis, pas de bordure sur les tapis ronds. - Rand met bies alleen op de lengte van het tapijt, geen biesrand bij ronde tapijten.

# POUFS - POEFS



## BAY small

	DEPOUBAY.RS	small - ø 50 x 40 cm, 19 x 16" fabric of choice		see overview below
	OPTIONAL	piping passepoil biesa	 Y08 biarritz <b>NEW</b>	
			 Y41 blade <b>NEW</b>	

fabric of choice - tissu de choix - stof naar keuze:

	cat. A	cat. B	cat. C	cat. D
	€ 495	€ 545	€ 595	€ 615
incl. piping - passepoil - bies	€ 515	€ 565	€ 615	€ 635

## BAY medium



	DEPOUBAY.RM	medium - ø 50 x 50 cm, 19 x 19" fabric of choice		see overview below
	OPTIONAL	piping passepoil biesa	 Y08 biarritz <b>NEW</b>	
			 Y41 blade <b>NEW</b>	

fabric of choice - tissu de choix - stof naar keuze:

	cat. A	cat. B	cat. C	cat. D
	€ 575	€ 615	€ 645	€ 675
incl. piping - passepoil - bies	€ 595	€ 635	€ 665	€ 695









## BAY large

	<b>DEPOUBAY.RL</b>	large - ø 80 x 40 cm, 32 x 16" fabric of choice		see overview below
	<b>OPTIONAL</b>	 piping passepoil biesa	 Y08 biarritz <b>NEW</b>	
		 Y41 blade <b>NEW</b>	 Y41 blade <b>NEW</b>	

fabric of choice - tissu de choix - stof naar keuze:

	cat. A	cat. B	cat. C	cat. D
	€ 725	€ 755	€ 795	€ 835
incl. piping - passepoil - bies	€ 745	€ 775	€ 825	€ 865

## COCO

	<b>DEPOUCOC.RS</b> round small ø 50 x 40 cm, 19 x 16"		D72 camel	€ 365
	<b>DEPOUCOC.RM</b> round medium ø 50 x 50 cm, 19 x 19"		D72 camel	€ 395
	<b>DEPOUCOC.RL</b> round large ø 80 x 40 cm, 32 x 16"		D72 camel	€ 595
	<b>DEPOUCOC.SS</b> square small 50 x 40 cm, 20 x 16"		D72 camel	€ 395
	<b>DEPOUCOC.SL</b> square large 100 x 40 cm, 39 x 16"		D72 camel	€ 895

hand braided polyolefin rope - corde en polyolefin, tressé à la main - handgevlochten polyolefin touw

# LIGHTING - ÉCLAIRAGE - VERLICHTING

## SOLORE SQUARE







	<b>DELIGSOL.CS</b> cube small 25 x 25 cm, 10 x 10"	 F15 natural	€ 395
		 F17 taupe	
	<b>DELIGSOL.CM</b> cube medium 33,5 x 33,5 cm, 13 x 13"	 F15 natural	€ 455
		 F17 taupe	
	<b>DELIGSOL.CL</b> cube large 43 x 43 cm, 17 x 17"	 F15 natural	€ 495
		 F17 taupe	

Solar-powered LED lamp for warm outdoor light. Rechargeable battery with solar energy or USB. Can be placed on the ground or hung up. Supplied with rope and USB cable. Control the light with the application "**SLS Control**". Available in the App Store and Google Play. The Solore Solar Module is included.

Lumière solaire à LED fournissant une lumière extérieure. Batterie rechargeable avec énergie solaire ou USB. Peut ce tenir seul ou être suspendu. Fourni avec une corde & câble USB. Fonctionnement de la lumière avec l'application "**SLS Control**". Disponible à l'App Store et Google Play. Le Solore Solar Module est inclus.





LED-lamp op zonne-energie voor warm buitenlicht. Oplaadbare batterij met zonne-energie of USB. Kan op de grond geplaatst worden of worden opgehangen. Geleverd met touw en USB-kabel. Bedien het licht met de applicatie "**SLS Control**". Verkrijgbaar in de App Store en Google Play. De Solore Solar Module is inbegrepen.

## SOLORE SPHERE

	<b>DELIGSOL.SS</b> sphere small ø 30 x 24,5 cm, 12 x 10"	 F15 natural	€ 395
		 F17 taupe	
	<b>DELIGSOL.SM</b> sphere medium ø 38,5 x 33,5 cm, 15 x 13"	 F15 natural	€ 455
		 F17 taupe	
	<b>DELIGSOL.SL</b> sphere large ø 47,5 x 43 cm, 19 x 17"	 F15 natural	€ 495
		 F17 taupe	



	<b>DEALIGSOL-DSP01</b> solore solar hybrid module	medium	€ 225
---	--	--------	-------

**NOTO OVAL**

	<b>DELIGNOT.S</b> oval small ø 39 x 48.5 cm, 15 x 19"	 A31R32 charcoal & black	€ 375
		 A31R06 charcoal & natural	
	<b>DELIGNOT.L</b> oval large ø 48 x 60 cm, 19 x 24"	 A31R32 charcoal & black	€ 445
		 A31R06 charcoal & natural	



hand woven rope with solar lamp - cordage tissée à la main avec lumière solaire - handgeweven touw met lamp op zonne-energie

**NOTO CONIC**

	<b>DELIGNOT.CS</b> conic small	 A31R06 charcoal & natural	€ 395
	<b>DELIGNOT.CL</b> conic large	 A31R06 charcoal & natural	€ 695

hand woven rope with solar lamp - cordage tissée à la main avec lumière solaire - handgeweven touw met lamp op zonne-energie

**ARCQ**



	<b>DELIGARC.S</b> small ø 39 x 48.5 cm, 15 x 19"	 F18 straw	€ 375
	<b>DELIGARC.L</b> large ø 48 x 60 cm, 19 x 24"	 F18 straw	€ 445

synthetic material with solar lamp - fibre synthétique avec lumière solaire - synthetisch materiaal met lamp op zonne-energie

	<b>UALIG-SP052</b> solar module Noto & Arcq		€ 95
---	--	--	------



# ACCESSORIES - ACCESSOIRES

## ANTIBES

	<b>DEDECANT-TUB.01</b> winetub ø 50 x 22.5 cm, 19.7 x 9"		W62 teak	€ 395
	<b>DEDECANT-COOL.01</b> winecooler ø30 x 30 cm, 12 x 12"		W62 teak	€ 225

teak with stainless steel parts - teak avec des pièces en acier inoxydable - teak met RVS onderdelen

## PRANA

	<b>DEBASPRA-SET</b> ø 45 x 40 cm, 17.2 x 15.7" ø 65 x 58 cm, 25.6 x 22.8"		D05 seal	€ 1.395
---	---	---	----------	---------

PVC coated polyester - polyester enduit de PVC - polyester met PVC coating

# DECO CUSHIONS - COUSSINS DE DÉCORATION - DECOKUSSENS

## DECO CUSHION



	Cat. A	Cat. B	Cat. C	Cat. D	Cat. E
CUDECO40X40 40 x 40 cm	€ 95	€ 105	€ 115	€ 125	€ 145
CUDECO50X30 50 x 30 cm					
CUDECO50X50 50 x 50 cm	€ 125	€ 130	€ 135	€ 145	€ 185

overview of the fabrics - aperçu des tissus - overzicht van de stoffen: see website

# MAINTENANCE & PROTECTION - ONDERHOUD & BESCHERMING

COVER - HOUSSE - HOES					
	UPJCP.1S-X77	JCP.1 Series	190 x 30 x 60 cm	100% solution dyed polyester with PU coating	€ 95
	UPJCP.202-X77	JCP. 202	380 x 43.5 x 85 cm		€ 295
	UPJCP.2S-X77	JCP.201 & JCP.203	325 x 34.5 x 75 cm		€ 295
	UPJCP.3S-X77	JCP.3 Series	250 x 55 x 74.5 cm		€ 175
	UPJCP.4S-X77	JCP.4 Series	275 x 35.5 x 65 cm		€ 215
	UPJCP.5S-X77	JCP.5 Series	4* 250 x 53 x 72 cm		€ 595
	UPJCP.6S-X77	JCP.6 Series	2* 245 x 52 x 71 cm		€ 345
	UPAZO-M-X75	Azore	260 x 25 x 54 cm	100% polyester with PU coating	€ 75
	UPANT-M-X75	Antego	260 x 25 x 54 cm		€ 75
	UPLIM-L-X75	Lima	300 x 67 x 72.5 cm		€ 145
	UPUMB-S-X75	Tuli	190 x 30 x 60 cm		€ 75
	UPAMA-M-X75	Amalfi	220 x 30 x 60 cm		€ 75
	UPCUB-M	Cuba & Moorea	270 x 38 x 75 cm	100% solution dyed polyester	€ 175









To enhance the durability and appearance, we recommend following our care instructions regularly. The umbrella should never be used in strong wind or rainy conditions. An open umbrella should never be left unattended. We always suggest storing your furniture and outdoor umbrella in a dry place when not in use or using a protective cover to avoid any blurring or damage.

Pour améliorer la durabilité et l'apparence, nous vous recommandons de suivre nos instructions d'entretien régulièrement. Le parasol ne doit jamais être utilisé dans des conditions fortes ou pluvieuses. Un parasol ouvert ne doit jamais être laissé sans surveillance. Nous suggérons toujours de ranger vos meubles et votre parasol dans un endroit sec lorsqu'ils ne sont pas utilisés ou d'utiliser une housse de protection pour éviter la décoloration et les dommages.

Om de duurzaamheid en het uiterlijk te verbeteren, raden we aan om regelmatig onze instructies op te volgen. De parasol mag nooit gebruikt worden in harde wind of regenachtige omstandigheden. Een geopende parasol mag nooit zonder toezicht worden achtergelaten. We raden altijd aan om uw parasol of meubels op een droge plaats op te bergen wanneer ze niet worden gebruikt, of om een beschermhose te gebruiken om vervaging of beschadiging te voorkomen.

# MAINTENANCE & PROTECTION - ONDERHOUD & BESCHERMING

## ALUMINIUM

	<b>SPCOR-12ML</b> corrector pen	 A01 white	€ 45
		 A03 linen	
		 A11 taupe	
		 A14 lava	
		 A30 anthracite	
		 A31 charcoal	
		 A32 black	

Quick-drying liquid paint with built-in brush for powder-coated surfaces.  
Ideal for retouching small surface traces (scratches, wear).

Peinture liquide à séchage rapide avec pinceau intégré pour les surfaces thermolaqué.  
Idéale pour retoucher les petites marques de surface (rayures, abrasion).

Sneldrogende vloeibare verf met ingebouwde borstel voor gepoederlakte oppervlakken.  
Ideaal voor het retoucheren van kleine oppervlaktesporen (krassen, slijtage).

## FABRICS

	<b>SPCARE-TEXT-75CL</b> fabrics tissus stoffen	2 sponges, 3 application cloths 1 textile protector 750ml 1 textile cleaner 750ml  2 sets de récurage, 3 chiffons 1 protecteur textile 750ml 1 nettoyant textile 750ml  2 sponzen, 3 doeken 1 textielbeschermer 750ml 1 textielreiniger 750ml	€ 75
---	---	---	------

## STONE

	<b>SPCARE-STONE-50CL</b> natural stone pierre naturelle natuursteen	1 sponge, 1 applicaton cloth 1 natural stone protector 500ml 1 natural stone cleaner 500ml  1 éponge, 1 chiffon d'application 1 protecteur de pierre naturelle 500ml 1 nettoyant de pierre naturelle 500 ml  1 spons, 1 doek 1 natuursteen beschermer 500 ml 1 natuursteen reiniger 500 ml	€ 75
---	--	--	------

## PARASOL ACCESSORIES - ACCESSOIRES



### LUNA LED LIGHT

UALUN-LED02

You create a warm glow by adding this outdoor umbrella light to the built-in holder on the frame. Luna LED light is wireless with 16 LEDs and gives a warm color. Using the BT speaker, the module will play music for six to ten hours.

On peut créer une lueur chaleureuse en ajoutant cette lampe de parasol à un support intégré sur le structure de parasol. La lumière LED Luna est sans fil avec 16 LED et donne une couleur douce. En utilisant le haut-parleur BT, il vous permet d'écouter de la musique pendant six à dix heures.

Je creëert een warme gloed door deze parasollamp toe te voegen aan de ingebouwde houder op het parasolframe. Luna LED light is draadloos met 16 LED's en geeft een warme kleur. Aan de hand van de BT-luidspreker, speelt de module zes tot tien uur lang muziek.

**colour - couleur - kleur:** grey - gris - grijs

**light - lumière - licht:** LED warm light - lumière douce - warm licht

**fits on - s' adapte sur - past op:** Attitude collection; Azore - Antego - Lima - Tuli - Amalfi - Malibu

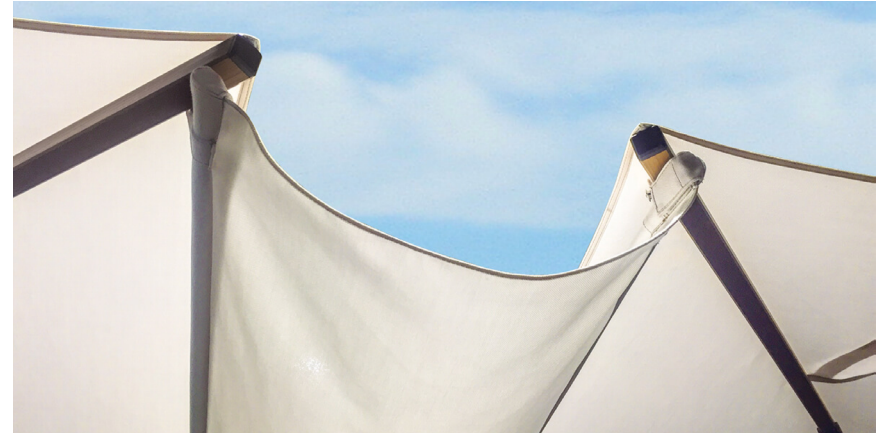

### GUTTERS

Gutters offer an uninterrupted protection between several umbrellas. By connecting the parasols, large areas have a complete coverage against the sun or rainy weather. A gutter is always attached to the parasol with a slight slope in order to drain the water efficiently in the desired directions.

Our gutters are available in the same colour as the cloth of the parasol to match perfectly. Only applicable on the following parasols: JCP.201 (p. 12), JCP.202 (p. 13) and JCP.501 (p. 22).

### GOUTIÈRES

Les gouttières offrent une protection ininterrompue entre plusieurs parasols extérieurs. La connexion des parasols permet de grandes zones d'avoir une couverture complète contre le soleil ou les conditions météorologiques pluvieuses. Une gouttière est toujours attachée au parasol à une légère baisse pour permettre à l'eau de s'écouler efficacement dans les directions souhaitées.

Ils sont disponibles dans la même couleur que votre toile pour se fondre parfaitement. Uniquement applicables sur les parasols suivants: JCP.201 (p. 12), JCP.202 (p. 13) and JCP.501 (p. 22).

### GOTEN

Goten bieden ononderbroken bescherming tussen meerdere parasols. Door de parasols aan elkaar te koppelen, hebben grote oppervlakten een volledige dekking tegen de zon of regenachtige weersomstandigheden. Een goot wordt altijd met een lichte helling aan de parasol bevestigd om het water efficiënt in de gewenste richtingen af te voeren.

Onze goten zijn beschikbaar in dezelfde kleur als het doek van de parasol om er perfect bij te passen. Enkel van toepassing op de volgende parasols: JCP.201 (p. 12), JCP.202 (p. 13) and JCP.501 (p. 22).



UMBRELLAS

CATEGORY 3

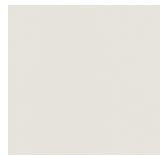

C003 pearl



C011 cotton



C022 nile



C025 mushroom



C026 howlite



C027 moonstone



C028 flax



C029 wheat

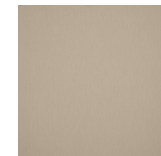

C030 papyrus



C031 nutmeg



C100 ice

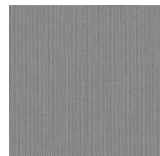

C107 mooncrest



C114 concrete



C115 cadet

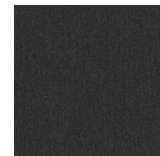

C207 onyx

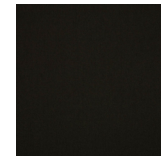

C210 pitch



C216 rock



C217 iron

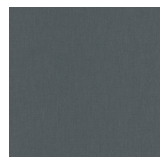

C218 pewter

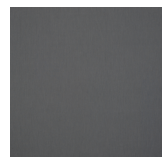

C219 titanium

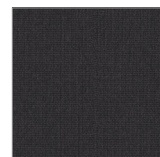

C220 basalt

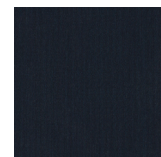

C221 faroe



C222 slate



C305 umber

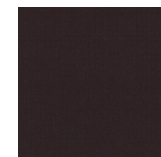

C308 gravel



C309 ebène



C452 sunset



C453 rotala



C454 gobi



C455 burgundy



C456 crimson



C457 sunrise

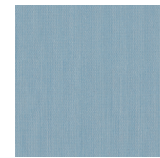

C458 fjord



C459 lapis

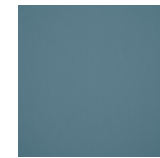

C460 celestial



C461 marine



C462 teal

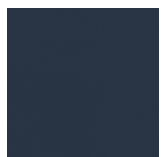

C463 navy



C464 glacier



C465 loyal

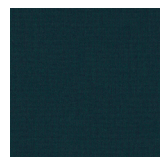

C466 emerald



C468 berry

# FABRICS - TISSUS - STOFFEN

## CATEGORY 2



C019 tofu



C020 powder



C023 heather



C032 tulle



C033 lin



C034 antique



C035 trush



C036 fawn



C112 fog

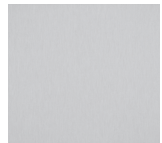

C113 plaster

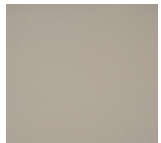

C116 cobble

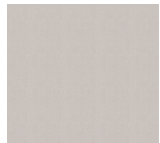

C117 milk

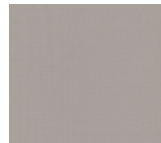

C118 steam

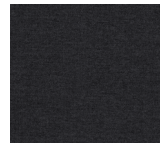

C214 eclipse

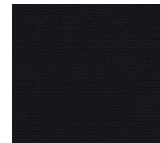

C215 shadow



C223 fuel

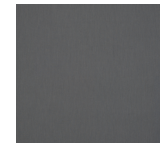

C224 lead



C225 ardoise



C226 tweed



C227 blackboard

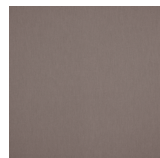

C307 cacao



C310 amber



C311 vino



C312 chestnut



C313 auburn



C314 chocolate



C402 tangerine



C403 pink

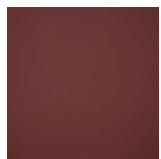

C409 brick



C443 moss



C444 peach



C450 arctic

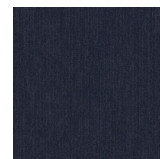

C451 belharra

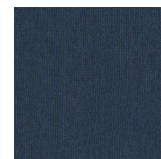

C469 mistral



C470 merlot



C471 antelope



C472 hive



C473 poppy



C474 pepper



C475 vivid



C476 calathea

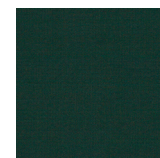

C477 pinea



C478 macao



C479 lichen



C480 seafoam

# FABRICS - TISSUS - STOFFEN



C481 beryl



C482 adriatic



C483 trust



C484 cyan



C485 curacao

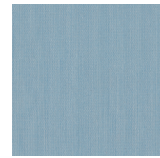

C486 crisp

## CATEGORY 1



C001 natural



C010 latte



C024 clay

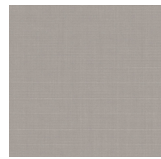

C101 cloud

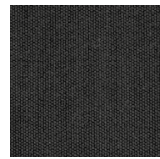

C208 black



C211 steel



C304 walnut

	CATEGORY 3	CATEGORY 2	CATEGORY 1
<b>COMPOSITION</b>	100% solution dyed acrylic	100% solution dyed acrylic	100% solution dyed polyester
<b>GRAMMAGE</b>	320 g/m <sup>2</sup>	260 g/m <sup>2</sup>	270 g/m <sup>2</sup>
<b>LIGHTFASTNESS</b>	level 7-8	level 7-8	level 6-7
<b>WATER RESISTANCE</b>	1000 mm	400 mm	100 mm
<b>UV PROTECTION</b>	> 98%	> 98%	> 98%

# MATERIALS - MATERIAUX - MATERIALEN

## CARACTÈRE COLLECTION

### ALUMINIUM frame - structure

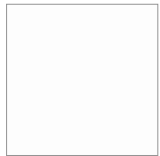

A01 white



A03 linen



A10 cappuccino



A12 alu teak



A31 charcoal



A32 black

Powdercoated aluminium.

Aluminium thermolaqué.

Gepoederlakt aluminium.

### STEEL - ACIER - STAAL Caractère collection umbrella base - base du parasol - parasolvoet

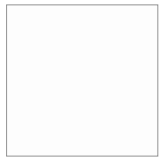

S01 white



S03 linen



S31 charcoal

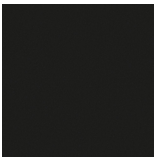

S32 black

Hot galvanised powder coated steel plates,  
heavy and rust free.

Tôle d'acier galvanisé à chaud et thermolaqué,  
lourd et inoxydable.

Warm verzinkte en gepoederlakte staalplaat,  
zwaar en roestvrij.

## ATTITUDE COLLECTION

### ALUMINIUM frame - structure



A01 white



A03 linen



A08 matt oak



A12 alu teak



A14 lava



A30 anthracite



A32 black

Powdercoated aluminium.

Aluminium thermolaqué.

Gepoederlakt aluminium.



# MATERIALS - MATERIAUX - MATERIALEN

## **NATURAL STONE - PIERRE NATURELLE - NATUURSTEEN** umbrella base - base du parasol - parasolvoet



**G04** light grey granite



**G13** Egyptian sandstone



**G32** black granite

Extremely strong and low porous. Stain repellent, UV-resistant, and resistant to heat, frost and mold. Due to its natural composition, variations in colour and pattern are inherent to each stone.

Extrêmement solide et peu poreux. Il est antitache, résistant aux UV, à la chaleur, au froid et au champignon. En raison de sa composition naturelle, les variations de couleur et de motif sont inhérentes à chaque pierre.

Extreem sterk en weinig poreus. Vlekafstotend, UV-bestendig en bestand tegen hitte, vorst, en schimmel. Door de natuurlijke samenstelling zijn variaties in kleur en patroon inherent aan elke steen.

## **STEEL - ACIER - STAAL** umbrella base - base du parasol - parasolvoet

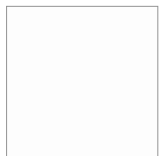

**S01** white



**S03** linen

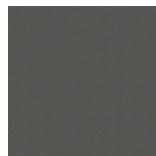

**S30** anthracite

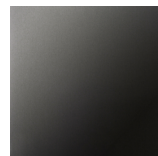

**S31** charcoal



**S32** black

Hot galvanised powder coated steel plates, heavy and rust free.

Tôle d'acier galvanisé à chaud et thermolaqué, lourd et inoxydable.

Warm verzinkte en gepoederlakte staalplaat, zwaar en roestvrij.

## **CONCRETE - BÉTON - BETON** umbrella base - base du parasol - parasolvoet



**B01** white



**B03** linen



**B06** hazel



**B30** anthracite



**B32** black

Robust and long-lasting, resistant to frost and heat.

Robuste et durable, résistant au froid et à la chaleur.

Robuust en duurzaam, bestand tegen vorst en hitte.

# WIND SCALE - ÉCHELLE DU VENT - WINDSCHAAL

The wind speed indicated in this price list is the maximum wind speed the parasol can be exposed to. A parasol is the most vulnerable piece of furniture in your garden or on your terrace. Weather conditions and external environmental factors are the biggest dangers for the life span of a parasol. Therefore, we recommend you to regularly follow our maintenance instructions.

**Please note:** damage caused by wind is not covered by our warranty. In case of wind, it is recommended to close the parasol, take it off its base and store it horizontally. This reduces the chance of damage to the parasol and other belongings.

## TIPS FOR THE IDEAL POSITION OF THE UMBRELLA

### FREE POLE UMBRELLA

If you want to tilt the parasol in height (2), we advise you to position the back side of the pole against the wind direction (1). You will now be able to tilt the parasol without it catching wind from below.

If the wind reaches the parasol from another direction, we advise to always position the parasol horizontally (3). Make sure the inside of the parasol never catches wind (5) to prevent it from collapsing. It is important that the parasol is fully opened with tension on the cloth and always stands on a flat surface.

### CENTER POLE UMBRELLA

We recommend always avoiding wind from below. Make sure the parasol is fully opened and stands on a flat surface.

La vitesse du vent indiquée dans ce tarif est la vitesse maximale du vent à laquelle le parasol peut être exposé. Un parasol d'extérieur est le meuble le plus vulnérable de votre jardin ou de votre terrasse. Les plus grandes menaces pour la durée de vie d'un parasol sont les conditions météorologiques et les facteurs environnementaux. C'est pourquoi nous vous suggérons de suivre régulièrement nos instructions d'entretien.

**Attention :** les dommages dus au vent ne sont pas couverts par notre garantie. En cas de vent, il est recommandé de fermer le parasol, de le retirer de son socle et de le positionner horizontalement. Cela réduira les risques d'endommagement de votre parasol et de vos autres possessions ou biens.

## CONSEILS POUR LA POSITION IDEALE DU PARASOL

### PARASOL À MÂT LIBRE

Si vous souhaitez incliner votre parasol en hauteur (2), nous conseillons de positionner l'arrière du mât dans le sens contraire du vent (1). Vous pouvez ainsi incliner votre parasol sans qu'il ne prenne le vent par le bas. Lorsque le vent atteint le parasol depuis une autre direction, nous conseillons de toujours mettre le parasol horizontalement (3). Pour éviter que le parasol ne tombe, assurez-vous que l'intérieur du parasol n'est jamais face au vent (5). Il est important que le parasol soit complètement ouvert avec une tension totale sur la toile et qu'il repose toujours sur une surface plane.

### PARASOL À MÂT CENTRAL

Nous vous conseillons de toujours éviter le vent par le bas. Veillez à ouvrir complètement le parasol et à le poser sur une surface plane.

De windsnelheid die weergegeven wordt in deze prijslijst is de maximale windsnelheid waaraan de parasol blootgesteld kan worden. Een parasol is het meest kwetsbare stuk in uw tuin of op uw terras. De grootste gevaren voor de levensduur van een parasol zijn de weersomstandigheden en externe omgevingsfactoren. Daarom raden wij aan om onze onderhoudsinstructies regelmatig op te volgen.

**Let op:** schade ten gevolg van wind valt niet onder onze garantie. In geval van wind is het aan te raden de parasol te sluiten, van de voet te halen en horizontaal op te bergen. Dit verkleint de kans op schade aan de parasol en andere bezittingen of eigendommen.

## TIPS VOOR DE IDEALE POSITIE VAN DE PARASOL

### VRIJHANGENDE PARASOL

Indien je de parasol in hoogte wilt kantelen (2), adviseren wij om de achterkant van de mast tegen de windrichting in te plaatsen (1). Je kan nu de parasol kantelen zonder dat deze wind van onderaan opvangt.

Wanneer de wind de parasol vanuit een andere richting bereikt, adviseren wij om de parasol altijd horizontaal te plaatsen (3). Zorg ervoor dat de binnenkant van de parasol nooit wind opvangt (5) om te voorkomen dat de parasol omvalt. Het is belangrijk dat de parasol volledig geopend is met spanning op het doek en altijd op een vlakke ondergrond staat.

### PARASOL MET CENTRALE MAST

We adviseren om altijd wind van onderaan te vermijden. Zorg ervoor dat de parasol volledig open is en op een vlakke ondergrond staat.

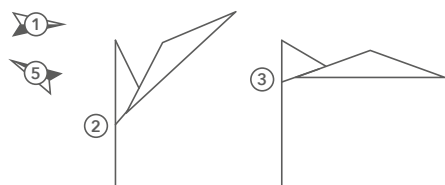

# WIND SCALE - ÉCHELLE DU VENT - WINDSCHAAL

beaufort N°.	description - omschrijving	Km/h	Mph	conditions at sea - conditions de la mer - condities op zee	conditions on land conditions terrestres - condities op het land	Parasol
0	calm calme kalm	< 1	< 1	The sea is like a mirror. La mer est comme un miroir. De zee is als een spiegel.	Calm, smoke rises vertically. Calme, la fumée s'élève verticalement. Kalm, rook stijgt verticaal op.	
1	light air air léger lichte lucht	1 - 5	1 - 3	Ripples form on the surface, without foam ridges. Des ondulations se forment à la surface, sans crêtes d'écume. Rimpelingen aan het oppervlak, zonder schuimruggen.	Smoke drift indicates wind direction. La dérive de la fumée indique la direction du vent. Rookdrift geeft windrichting aan.	
2	light breeze brise légère lichte briesje	6 - 11	4 - 6	Small waves. Petites vaguelettes. Kleine golfjes.	Wind can be felt on the face, leaves rustle. Vent ressenti sur le visage, les feuilles bruissent. Wind voelbaar op gezicht, bladeren ritselen.	
3	gentle breeze souffle léger zachte bries	12 - 19	7 - 10	Larger waves of 0.5 to 1 m. Grandes vaguelettes de 0.5 à 1 m. Grotere golfjes van 0.5 tot 1 m.	The leaves and small branches are constantly moving. Les feuilles et les petites brindilles sont en mouvement constant. Bladeren en kleine takjes zijn in beweging.	
4	moderate breeze brise modérée matige wind	20 - 28	11 - 16	Small wave of 1 to 2 m that grows longer. Petite vague de 1 à 2 m qui s'allonge. Kleine golf van 1 tot 2 m die langer wordt.	Dust, leaves and loose paper come up, small branches move. Poussière, feuilles et papiers détachés soulevés, petites branches bougent. Stof, bladeren en los papier komen omhoog, kleine takken bewegen.	Azore
5	cool breeze brise fraîche frisse bries	29 - 38	17 - 21	Moderate waves of 2 to 3 m. Les vagues modérées de 2 à 3 m. Matige golven van 2 tot 3 m.	Small trees begin to sway. Les petits arbres commencent à se balancer. Kleine bomen beginnen te zwaaien.	
6	strong breeze brise forte sterke bries	39 - 49	22 - 27	Large waves of 3 to 4 metres begin to form. De grandes vagues de 3 à 4 m commencent à se former. Grote golven van 3 tot 4 m beginnen zich te vormen.	Large branches in motion, umbrellas used with difficulty. Grosses branches en mouvement, parapluies sont utilisés avec difficulté. Grote takken in beweging, paraplu's met moeite gebruikt.	JCP.1 series, Cuba, Moorea, Lima, Antego, Amalfi
7	strong breeze, almost storm vent fort, proche du coup de vent harde wind, bijna storm	50 - 61	28 - 33	Waves of 4.5 to 5 m. The white foam of breaking waves is blown in the direction of the wind. Vagues modérées de 4.5 à 5 m. L'écume blanche des vagues déferlantes est poussée dans la direction du vent. Golven van 4.5 tot 5 m. Het witte schuim van brekende golven wordt in de richting van de wind geblazen.	Trees in motion, discomfort felt when walking against the wind. Arbres en mouvement, inconfortables lorsqu'on marche contre le vent. Bomen in beweging, ongemak gevoeld bij het lopen tegen de wind in.	JCP.2, 3, 4, 5 & 6 series
8	storm coup de vent	62 - 74	34 - 40	Moderately high waves of 5 to 7 m. Des vagues modérément hautes de 5 à 7 m. Matig hoge golven van 5 tot 7 m.	Branches and small branches break off from trees. Des brindilles et des petites branches se sont détachées des arbres. Takjes en kleine takken breken van bomen af.	Tuli
9	strong storm coup de vent fort sterke storm	75 - 88	41 - 47	High waves of 7 to 10 m. The sea begins to roll, mist affects visibility. Hautes vagues de 7 à 10 m. La mer commence à rouler, les embruns affectent la visibilité. Hoge golven van 7 tot 10 m. De zee begint te rollen, nevel tast het zicht aan.	Light structural damage. Légers dommages structurels. Takjes en kleine takken breken van bomen af.	
10	severe storm tempête zware storm	89 - 102	48 - 55	Very high waves of 9 to 12 m with long overhanging ridges. Très hautes vagues de 9 à 12 m avec de longues crêtes en surplomb. Zeer hoge golven van 9 tot 12 m met lange overhangende ruggen.	Rarely encountered on land. Trees uprooted, structural damage. Rarement ressenti sur terre. Arbres déracinés, dommages structurels. Zelden op het land ondervonden. Bomen ontworteld, structurele schade.	

# GENERAL TERMS & CONDITIONS

## GENERAL

Our general sales and delivery terms and conditions, as outlined here, are deemed to have been accepted by the customer, even if these terms and conditions are at odds with the general or special purchase terms and conditions of our customer. The said terms and conditions shall only have binding effect on us in case we expressly agree with the same. Our agreement can never be derived from the mere fact that the terms and conditions to which the customer refers would have been accepted tacitly by us.

The buyer expressly declares to have taken note of these general terms and conditions and to accept the same. They are consequently deemed to form an integral part of the contractual relationship between the parties.

## ORDERS

Offers and quotations are only provided by way of indication and can never bring about any obligation, unless expressly determined otherwise. As the occasion arises, they shall have a validity of at most one month, unless determined otherwise. Offers are always exclusive of VAT, transport charges, statutory duties and taxes, etc.

## PRICES

Each and every sale is based on prices and general terms and conditions as included in our order confirmation. The prices and technical descriptions in our general catalogue are for information purposes only, without any obligation deriving from the same. We can change our prices at any time on the basis of economic fluctuations. The valid prices are mentioned on the order confirmation on the date of the order. Our prices are always available on request. Errors may occur in the prices, descriptions or images of certain goods in our catalogues or our sales material. We reserve the right to limit orders of these products.

The shipping costs on your invoice differ from those on your confirmation. This is mostly due to instability of the fuel economy. Please take into account that these costs are charged by the carrier and not by JARDINICO Parasols. The shipping costs on the order confirmation therefore provide an approximate indication and the buyer cannot derive any rights from this.

The total amount of the invoice must be paid within the time limit specified on the invoice.

## DELIVERY CONDITIONS

Our delivery and completion time limit shall not have binding effect, unless expressly stipulated otherwise. A delay in the delivery / completion can by no means give cause to compensation or interest. Force majeure, lock-out, industrial action, war, epidemic, etc. both on our part and on the part of our suppliers shall release us from each and every responsibility.

## COMPLAINTS AND EXCHANGES

The complaints regarding deliveries or completion of works must be communicated to us by registered post within 5 days after receipt of the goods or completion / finishing of the works. The complaints regarding invoices must be communicated to us by registered post within 5 days after the date of receipt of the invoice.

Not a single return of goods shall be accepted without our prior consent and without a filled in 'after-sales service' form. This form must be filled in by an official commercial partner of JARDINICO Parasols. This can be done via the website if one is logged in or via your contact person at JARDINICO Parasols. Moreover, they can only be taken back if the return shipment takes place in the same good condition as upon delivery. If a complaint was not received within the aforementioned time limit of 5 days after receipt of the goods or completion / finishing of the works then the buyer is deemed to have received the goods in a good condition and waives each and every claim vis-à-vis the seller.

Goods potentially taken back are credited subject to a reduction of 20% of the invoiced value. Visible defects are assumed to have been accepted failing objections within the aforementioned time limit. For normal invisible defects our liability shall be limited to the indemnification that is commonly provided by our suppliers / subcontractors. Our liability shall be limited to the replacement of the delivered goods within the warranty period as determined below.

## PAYMENTS

Incomplete performance of works can by no means give cause to refusal of payment of the delivered goods or works. Partial invoicing is allowed according to the progress of the goods and/or performance of the works. Each and every payment must take place in cash at our seat upon invoicing, unless stipulated otherwise in advance and in writing. All our invoices are payable in Harelbeke within the due date mentioned on the invoice. Partial payment is allocated in conformity with Section 1254 of the Belgian Civil Code.

## UNPAID ORDERS

In case of full or partial non-payment of the debt on the due date the invoice amount is by operation of law and without prior notice of default increased by an interest rate of 12% per annum from the due date. Failing specification of a particular due date it is deemed to coincide with the date of the invoice. In case of full or partial non-payment of the debt on the due date without serious reason compensation is also by operation of law and without prior notice of default payable at 12% of the principal sum with a minimum of EUR 125.00 and a maximum of EUR 2,500.00, even if grace periods are awarded and without prejudice to the possibilities foreseen by Section 1244 of the Belgian Civil Code.

In case of collection of outstanding invoices and disputes about agreements that were not implemented the statutorily established legal aid fee can be claimed by way of compensation for the costs of the lawyer. Moreover, we can, without prejudice to our right to claim compensation, if the customer does not comply with its obligations in a timely fashion or does not comply either in whole or in part, consider, always with notice by registered post and without prior notice of default, the agreement to be fully or partly inoperative by operation of law. As the occasion arises the customer must forthwith and within 48 hours after receipt of the notice make the identifiable (not incorporated) goods available to us. The non-payment on the due date of an invoice implies that the payable balance of all other invoices immediately falls due by operation of law, regardless of the previously permitted payment conditions.

## OWNERSHIP RIGHTS

Without prejudice to the risk of the customer with regard to the goods, we reserve the title of the goods delivered by us up to payment in full of the price. Upon the conclusion of the agreement and prior to the delivery of the goods the customer is expressly pointed to the said reservation of title and is, barring written objections, at the latest at the moment of the delivery, deemed to agree with the same. We also reserve the right to, provided with prior written notice of default, exercise a right of retention in respect of the goods of the customer that are in our possession by way of security for all outstanding claims.

In case of delivery of goods the risk for loss transfers, unless determined otherwise, as soon as the customer is informed that the goods are available at our seat. If the goods are stored further by us or are transported at the request of the customer then this takes place at the risk and expense of the customer. We, as well as the customer, expressly declare that any and all receivables of any nature whatsoever, present and future, that we have vis-à-vis each other are automatically settled between us with any and all payables of any nature whatsoever, present and future, that we are due vis-à-vis each other and the latter at the moment of the occurrence of the respective receivables and payables, regardless of their exigibility. In case of insolvency or dissolution of the customer of if the customer applies for a voluntary composition or legal restructuring in conformity with the Belgian Act of 31 January 2009 on the continuity of undertakings, we shall be entitled, at the moment of the insolvency declaration, dissolution or application for one of the procedures pursuant to the Belgian Act of 31 January 2009 by the customer, to settle receivables of any nature whatsoever still outstanding in respect of the customer, whether or not due and payable, with the then also still existing payables for our benefit, before one or more payments shall be made to the joint creditors of the insolvent, dissolved customer or customer relying on the Belgian Act of 31 January 2009.

## WARRANTY

We provide, barring different agreement of more or less, a maximum warranty of 2 years on our products. The warranty takes effect on the day that the product is purchased from an official commercial partner of JARDINICO Parasols (date of invoicing). The warranty applies to production and/or materials errors, caused by normal use. The product shall not be replaced in its entirety if a defective part and/or component can be replaced. JARDINICO Parasols shall by no means be held to provide a warranty if the defects are the result of improper or incorrect use by the final user.

## EXCEPTIONS TO THE WARRANTY

The warranty applies to production and/or materials errors, caused by normal use. The product shall not be replaced in its entirety if a defective part and/or component can be replaced. This warranty does not cover defects caused by incorrect assembly, defects as a result of changes by the buyer, intentional damages, incorrect use, abuse or negligence, not buying an associated base or ground anchor and normal wear and tear as a result of ageing and labour or assembly costs. The replacement of components shall be carried out by the final user or the retailer. JARDINICO Parasols limits itself, as the occasion arises, to making the components and/or parts to be replaced available to the said final user or retailer.

Our company reserves the right to remove a model from our collection at any time and without prior notice. All our spare parts remain in stock up to 2 years after the product has been discontinued. If the buyer establishes not to dispose of user instructions or user instructions that are unclear to the buyer then the buyer must report this immediately when making the purchase. If the buyer proceeded with installation of the purchased product, without the said notification, then the warranty expires. Products purchased during the sale before the end of a collection are never replaced or repaid. Parasol ribs fall outside the present warranty.

## DAMAGE DUE TO WIND DOES NOT FALL UNDER OUR LIMITED WARRANTY.

Natural disasters (including but not limited to wind, hurricanes, tornadoes and storms) and natural aspects of the ageing process do not fall under this warranty and are therefore not qualified as a defect. Not a single parasol, regardless of the size or the weight, can be left unattended in an open position. In case of windy circumstances it is recommended to close the parasols, to remove them from their base and to store or position them horizontally. This shall reduce the chance of damage to your parasol and other possessions or belongings.

The warranty does not cover discolouration, the bleeding of colours, changes in textures, scratches, breaks in or damages to lacquer due to use and/or defective maintenance / incorrect use. This enumeration is not exhaustive.

In due course natural teal turns grey. The surface may show discolouration. Appropriate treatments are available to ensure that the parasols retain their original appearance. Do not let dirt accumulate at the base. It is recommended to clean with mild soap and water. Never leave the base of the parasol standing in water. In case of use at the beach or an indoor pool salt and chlorine may accumulate on the powder coating and affect the finishing. To make sure that the base continues looking its best, you can best store it if it is not being used for a longer period of time.

The buyer expressly acknowledges to be informed of the above and also acknowledges that they cannot be qualified as a defect within the meaning of Section 1649ter of the Belgian Civil Code. The buyer moreover expressly acknowledges to have been informed of the fact that during the treatment of fabrics and metals colour differences may occur. The mere establishment of these kinds of colour differences shall never give cause to refusal of a delivery, unless the contrary was stipulated in advance and in writing.

## COMPETENT COURT

Only the courts of the district of Kortrijk are competent in respect of any and all disputes and Belgian law is applicable. Only JARDINICO Parasols can deviate from this.



# CONDITIONS GÉNÉRALES

## GÉNÉRALITÉS

Comme indiqué ci-après, les présentes conditions générales de vente sont réputées avoir été acceptées par le client, même si lesdites conditions sont contraires aux conditions générales ou à d'autres conditions particulières d'achat propres au client. Ces conditions ne peuvent nous engager qu'après notre accord exprès. Notre accord ne peut en aucun cas être supposé d'après quelque fait que ce soit selon lequel le client estime que notre silence vaut accord des conditions.

L'acheteur déclare avoir pris connaissance des présentes conditions générales et les accepter. En conséquence, lesdites conditions générales sont réputées faisant partie intégrante de la relation contractuelle existant entre les parties.

## COMMANDES

Les devis et tarifications proposées ne sont que des indications, et ne peuvent en aucun cas former un engagement, sauf si cela est expressément défini. Dans ce cas, les devis et tarifications proposées sont valables un mois maximum, sauf autre accord contraire. Les devis sont toujours exprimés hors TVA, hors frais de transport, hors charges légales, etc. ...

## PRIX

Chaque vente est basée sur les prix et les conditions générales tel qu'indiqué dans notre confirmation de commande. Les prix et descriptions techniques de notre catalogue n'ont qu'un but informatif et ne peuvent en aucun cas former un engagement. Nous nous réservons le droit de modifier nos prix à tout moment en fonction de la situation économique. Les prix applicables sont indiqués sur la confirmation de commande, à la date de la commande. Nos prix sont toujours disponibles sur simple demande. Il peut éventuellement y avoir des erreurs dans les prix, les descriptions ou les représentations de certains articles de notre catalogue ou de nos supports de vente. Nous nous réservons le droit de limiter le nombre de commandes de ces articles. Les frais de livraison indiqués sur votre facture peuvent différer du montant figurant sur votre confirmation. Cela est dû à l'instabilité du marché du carburant. Veuillez tenir compte du fait que ces frais sont calculés par le transporteur et pas par JARDINICO Parasols. Par conséquent, les frais de livraison figurant sur la confirmation de commande ne sont qu'indicatifs, et l'acheteur ne peut en tirer aucun droit. Le montant total de la facture doit être payé dans le délai indiqué sur la facture.

## CONDITIONS DE LIVRAISON

Nos délais de livraison et d'exécution ne sont pas contraignants, sauf autre accord contraire. Un retard de livraison ou d'exécution ne peut en aucun cas donner lieu à un dédommagement ou à des intérêts. Les cas de force majeure, de lock-out, de grève, de conflits armés, d'épidémie, etc., que ce soit pour notre entreprise ou nos fournisseurs, nous libèrent de toute responsabilité.

## RÉCLAMATIONS ET ÉCHANGES

Les réclamations relatives aux livraisons ou à l'exécution des travaux doivent nous être adressées par courrier recommandé dans les 5 jours après réception des marchandises ou après exécution / conclusion des travaux. Les réclamations relatives aux factures doivent nous être adressées par courrier recommandé dans les 5 jours après réception de la facture. Aucune marchandise ne sera reprise sans notre accord préalable et sans le formulaire rempli « service après-vente ». Ce formulaire doit être rempli par un partenaire officiel de JARDINICO Parasols. Cette démarche est possible en se connectant à votre espace ou en contactant votre personne de contact chez JARDINICO Parasols. En outre, les marchandises concernées ne peuvent être reprises que si elles sont en bon état, comme à la livraison. Si aucune réclamation n'est faite dans le délai précité de 5 jours après réception des marchandises ou après exécution / conclusion des travaux, l'acheteur est réputé les avoir accepté(e)s en bon état et renoncer à tout droit à l'égard du vendeur. Les éventuelles marchandises reprises feront l'objet d'un crédit diminué de 20 % du montant de la facture. Les défauts visibles sont réputés acceptés à défaut d'une réclamation dans les délais indiqués précédemment. Pour les défauts cachés et normaux, notre responsabilité se limite à la garantie offerte par nos fournisseurs ou nos sous-traitants. Notre responsabilité se limite au remplacement des marchandises livrées endéans les délais de garantie tel que prévu ci-dessus.

## PAIEMENTS

L'exécution incomplète des travaux ne peut en aucun cas donner lieu à un refus de paiement des marchandises livrées ou des travaux effectués. Une facturation partielle peut être réalisée selon la livraison des marchandises et/ou l'exécution des travaux. Chaque paiement doit être effectué en une seule fois, par facturation à notre siège, sauf autre accord écrit préalable. Toutes nos factures sont payées à Harelbeke dans le délai indiqué sur la facture en question. Le paiement partiel est appliqué conformément à l'art. 1254 du Code civil.

## COMMANDES IMPAYÉES

En cas de non paiement total ou partiel du montant dû à la date d'échéance de la facture, le montant de celle-ci est majoré de droit et sans mise en demeure préalable d'un intérêt de 12 % par an à compter de la date d'échéance. En cas d'absence de date d'échéance, celle-ci est supposée correspondre à la date de facturation. En cas de non-paiement total ou partiel du montant dû à la date d'échéance sans justification appropriée, un dédommagement à hauteur de 12 % du montant facturé est appliqué, avec un minimum de 125,00 EUR et un maximum de 2 500,00 EUR, de droit et sans mise en demeure préalable, même dans le cas où une période de différé a été accordée et sans préjudice des possibilités prévues à l'article 1244 du Code civil.

Dans la **structure** du recouvrement de factures impayées et de contestations quant à des accords non respectés, il peut être fait appel à une aide juridique servant de participation aux frais d'avocat. En outre, si le client ne respecte pas ses obligations dans les délais impartis, ou ne les respecte pas en tout ou en partie à tout moment, et sans préjudice de notre droit à exiger un dédommagement, nous nous réservons le droit de considérer le contrat comme nul, en tout ou en partie, par notification par courrier recommandé et sans mise en demeure préalable. Dans ce cas, le client est tenu de mettre à notre disposition les marchandises identifiables (non incorporées) le plus rapidement possible et au plus tard dans les 48 heures après la notification. Le non-paiement d'une facture rend le montant des autres factures immédiatement exigible de plein droit, peu importe les conditions de paiement acceptées préalablement.

## DROIT DE PROPRIÉTÉ

Sans préjudice du risque du client quant aux marchandises, nous conservons notre réserve de propriété sur les marchandises livrées jusqu'au paiement total du prix correspondant. Le client est expressément informé de cette réserve de propriété au moment de conclure le contrat et avant la livraison des marchandises et, à défaut de réclamation écrite au plus tard au moment de la livraison, il est réputé avoir accepté cette réserve. De plus, nous nous réservons le droit d'exercer un droit de rétention sur les marchandises du client toujours en notre possession pour servir de garantie aux créances en cours, à condition de lui faire parvenir au préalable une mise en demeure écrite. Pour la livraison des marchandises, et sauf autre accord contraire, le risque de perte est transféré dès que le client a été informé que lesdites marchandises sont disponibles à notre siège. Si les marchandises sont conservées dans nos locaux ou, sur demande du client, sont transportées ailleurs, c'est le client qui en porte la responsabilité et le risque. Nous-mêmes ainsi que le client déclarons expressément accepter que toutes les créances, de toute nature que ce soit, actuelles ou futures, et dont nous sommes redevables l'un à l'autre, soient compensées automatiquement par toute créance que ce soit, peu importe sa nature, qu'elle soit actuelle ou future et dont nous sommes redevables l'un à l'autre, et ce, au moment où apparaissent les créances respectives, peu importe leur exigibilité. En cas de faillite ou de dissolution du client, ou si le client demande un accord à l'amiable ou une réorganisation judiciaire, conformément à la loi du 31.01.2009 relative à la continuité des entreprises, nous avons le droit de compenser, à la charge du client, toute créance, de toute nature que ce soit, exigible ou non, encore existante au moment de la déclaration de faillite, de la dissolution ou de la demande de l'une des procédures prévues par la loi du 31.01.2009, avec les créances en notre faveur encore existantes à ce moment-là, avant de procéder à l'un ou l'autre versement aux créanciers communs du client failli, dissolu ou faisant appel à la loi du 31.01.2009.

## GARANTIE

Nous accordons, sauf autre accord contraire supérieur ou inférieur, maximum 2 ans de garantie sur nos produits. La garantie prend effet le jour où le produit est acheté auprès d'un partenaire officiel de JARDINICO Parasols (date de facturation). La garantie s'applique aux défauts de production et

ou aux défauts de matériau engendrés par un usage normal. Le produit ne sera pas entièrement remplacé si la pièce et/ou le composant défectueux peut être remplacé.

JARDINICO Parasols n'est aucun cas tenu d'offrir une garantie lorsque les défauts sont la conséquence d'un usage impropre ou abusif par l'utilisateur final.

## EXCLUSIONS DE GARANTIE

La garantie s'applique uniquement aux défauts de production et/ou aux défauts de matériau engendrés par un usage normal. Le produit ne sera pas remplacé si la pièce et/ou le composant défectueux peut être remplacé. La garantie ne couvre pas les défauts causés par une mauvaise installation, par des modifications effectuées par l'acheteur, ni les défauts intentionnels, ou causés par une mauvaise utilisation, une utilisation abusive ou par la négligence. Elle ne couvre pas non plus les défauts causés par le non-achat d'un pied ou d'une base adaptée, ni ceux causés par l'usure normale au fil du temps et de l'utilisation. Enfin, elle ne couvre pas non plus les frais d'installation. Le remplacement de pièces détachées sera effectué par l'utilisateur final ou par le commerçant de détail. Dans ce cas, JARDINICO Parasols s'engage seulement à mettre les pièces détachées et/ou les composants à remplacer à la disposition de l'utilisateur final ou du commerçant de détail. Notre entreprise se réserve le droit de retirer un modèle de sa collection, à tout moment, et sans notification préalable. Toutes les pièces détachées de réserve restent en stock 2 ans après l'arrêt de la production du produit concerné. Si l'acheteur indique ne pas être en possession d'un mode d'emploi ou être en possession d'un mode d'emploi imprécis pour lui, il doit immédiatement le dire au moment de l'achat. Si l'acheteur procède néanmoins à l'installation du produit acheté, sans avoir notifié l'absence de mode d'emploi, la garantie ne pourra pas être appliquée. Les articles achetés en liquidation de fin de série ne sont ni remplacés ni remboursés. Les baleines de parasols sont exclues de la garantie.

## LES DÉGÂTS CAUSÉS PAR LE VENT SONT EXCLUS DE LA GARANTIE.

Les catastrophes naturelles (y compris mais non limitées au vent, aux ouragans, aux tornades et aux tempêtes) ainsi que les aspects naturels du vieillissement sont exclus de la garantie et ne peuvent donc être considérés comme étant à l'origine de défauts. Aucun parasol, peu importe la taille ou le poids, ne doit être laissé en position ouverte sans surveillance. En cas de vents violents, il est fortement conseillé de fermer les parasols, de les enlever de leur pied et de les ranger à l'horizontale. Cela réduit le risque de dégâts sur votre parasol et sur d'autres objets et biens.

La garantie ne couvre pas la coloration, la décoloration, la modification de la texture, les rayures, les déchirures ou les dégâts à la peinture en lien avec l'utilisation et/ou le manque d'entretien ou la mauvaise utilisation. Cette liste est non exhaustive.

Avec le temps, le teck devient naturellement grisâtre. La surface peut prendre une certaine coloration. Il existe des traitements adaptés permettant de conserver l'état original des parasols. N'entassez aucun déchet au pied du parasol. Il est recommandé de nettoyer le parasol au savon doux et à l'eau. Ne laissez jamais le pied du parasol dans l'eau. En cas d'utilisation à la plage ou en piscine couverte, le sel et le chlore peuvent s'attaquer au revêtement et l'endommager. Pour garder le pied dans son état d'origine, il est recommandé de le ranger à l'abri lorsqu'il n'est pas utilisé sur une période prolongée.

L'acheteur déclare avoir été informé des questions traitées ci-dessus et accepte que celles-ci ne pourront pas être considérées comme non-conforme au contrat au sens de l'article 1649ter du Code civil.

L'acheteur déclare en outre être au courant du fait que le traitement de tissus et de métaux peut engendrer des variations de couleurs. L'identification simple de ces variations de couleurs ne peut en aucun cas donner lieu au refus de livraison, sauf accord contraire convenu au préalable.

## JURIDICTION

Tous les litiges sont la compétence exclusive des tribunaux de l'arrondissement de Courtrai et sont soumis au droit belge. Seul JARDINICO Parasols peut s'en écarter.

# ALGEMENE VOORWAARDEN

## ALGEMEEN

Onze algemene verkoop- en leveringsvoorwaarden zoals hierbij vermeld worden geacht door de klant te zijn aanvaard, zelfs indien deze voorwaarden in tegenspraak zijn met de eigen algemene of bijzondere aankoopvoorwaarden van onze klant. Deze voorwaarden kunnen ons enkel binden in geval uitdrukkelijk akkoord van onzentwege. Ons akkoord kan nooit worden afgeleid uit het enkele feit dat de voorwaarden waarnaar de klant verwijst door ons stilzwijgen zouden aanvaard zijn. De koper verklaart uitdrukkelijk kennis genomen te hebben van deze algemene voorwaarden en deze aanvaard te hebben. Bijgevolg worden deze geacht integraal deel uit te maken van de contractuele verhouding tussen partijen.

## BESTELLINGEN

Offertes en prijstellingen worden enkel als inlichting gegeven, maar kunnen nooit enige verbintenisse meebrengen, tenzij uitdrukkelijk anders bepaald. In dergelijk geval gelden zij hoogstens één maand, tenzij anders bepaald. Offertes zijn altijd exclusief BTW, transportkosten, wettelijke lasten en taksen, enz....

## PRIJZEN

Elke verkoop is gevoerd op prijzen en algemene voorwaarden zoals opgenomen in onze bestelbevestiging. De prijzen en technische omschrijvingen in onze algemene catalogus zijn slechts ter informatie, zonder dat daaruit enige verbintenis kan voortvloeien. We kunnen onze prijzen op elk moment herzien in functie van economische veranderingen. De geldige prijzen worden vermeld op de bestelbevestiging, op datum van de bestelling. Onze prijzen zijn te allen tijde beschikbaar op aanvraag. Er kunnen fouten voorkomen in de prijzen, beschrijvingen of afbeeldingen van bepaalde goederen in onze catalogus of ons verkoopmateriaal. Wij behouden ons het recht voor om bestellingen van die artikelen te beperken. De verzendkosten op uw factuur kunnen verschillen van die op uw bestelling. Dit komt grotendeels door instabiliteit van de brandstofeconomie. Houd er alstublieft rekening mee dat deze kosten door de vervoerder worden berekend, en niet door JARDINICO Parasols. De verzendkosten op de bestelbevestiging zijn derhalve slechts richtingsgevend en de koper kan hieruit geen enkel recht putten. Het totaalbedrag van de factuur moet betaald worden binnen de termijn die vermeld wordt op de factuur.

## LEVERINGSVOORWAARDEN

Onze levering- en uitvoeringstermijn is niet bindend, tenzij uitdrukkelijk anders overeengekomen. Een vertraging bij de levering/uitvoering kan in geen enkel geval aanleiding geven tot schadevergoeding of interesten. Overmacht, lock-out, staking, oorlog, epidemie, enz. ... zowel bij ons als bij onze leveranciers stellen ons vrij van elke verantwoordelijkheid.

## KLACHTEN EN OMRULINGEN

De klachten nopens leveringen of uitvoering van werken dienen per aangetekende brief aan ons te worden overgemaakt binnen de 5 dagen na ontvangst van de goederen of uitvoering/afwerking van de werken. De klachten nopens facturatie dienen per aangetekende brief aan ons te worden overgemaakt binnen de 5 dagen na datum van ontvangst van de factuur. Geen enkele terugname van goederen zal aanvaard worden zonder voorafgaandelijk akkoord van onzentwege en ingevuld formulier 'dienst na verkoop'. Dit formulier moet ingevuld worden door een officiële handelspartner van JARDINICO Parasols. Dit kan via de website wanneer men is ingelogd of via uw contactpersoon bij JARDINICO Parasols. Daarenboven kunnen zij slechts teruggenomen worden zo de terugzending geschiedt in dezelfde goede staat als bij aflevering. Indien geen klacht werd ontvangen binnen bovenstaande termijn van 5 dagen na ontvangst van de goederen of uitvoering/afwerking van de werken, wordt de koper geacht het goed ontvangen te hebben in een goede staat en ziet hij af van elk verhaal jegens de verkoper. Eventuele teruggenomen goederen worden gecrediteerd met een vermindering van 20% van de gefactureerde waarde. Zichtbare gebreken worden verondersteld aanvaard te zijn bij gebreke aan protest binnen de hoger omschreven termijn. Voor gewone verborgen gebreken zal onze aansprakelijkheid beperkt zijn tot de vrijwaring die gebeurlijk door onze leveranciers/onderaannemers wordt verstrekt. Onze aansprakelijkheid is beperkt tot de vervanging van de geleverde goederen binnen de garantietermijn zoals hieronder bepaald.

## BETALINGEN

Onvolledige uitvoering van werken kan in geen geval aanleiding geven tot weigering van betaling van de geleverde goederen of werken. Gedeeltelijke facturatie mag worden opgemaakt naargelang de levering der goederen en/of uitvoering van de werken. Elke betaling dient contant op onze zetel te gebeuren bij facturatie, tenzij voorafgaandelijk en schriftelijk anders werd overeengekomen. Al onze facturen zijn betaalbaar te Harelbeke binnen de op de factuur vermelde vervalt termijn. Gedeeltelijke betaling wordt toegerekend conform art. 1254 B.W

## ONBETAALDE BESTELLINGEN

Bij gehele of gedeeltelijke niet betaling van de schuld op de vervaldag wordt van rechtswege en zonder voorafgaandelijke ingebrekestelling het factuurbedrag verhoogd met een rente van 12% per jaar vanaf de vervaldag. Bij gebreke van betaling van een bijzondere vervaldag wordt deze geacht samen te vallen met de factuurdatum. In geval van gehele of gedeeltelijke niet betaling van de schuld op de vervaldag zonder ernstige reden wordt eveneens van rechtswege en zonder voorgaande ingebrekestelling een schadevergoeding aangerekend ten belope van 12% van de hoofdsom met een minimum van 125,00 EUR en een maximum van 2.500,00 EUR, zelfs bij toekenning van termijnen van respijt en zonder afbraak te doen aan de mogelijkheden voorzien door artikel 1244 B.W.

Bij invordering van openstaande facturen en betwistingen omtrent niet uitgevoerde overeenkomsten kan aanspraak gemaakt worden op de wettelijk vastgelegde rechtsplegingsvergoeding als tegemoetkoming in de kosten van de advocaat. Bovendien kunnen wij, onverminderd ons recht op schadevergoeding, indien de klant zijn verplichtingen niet tijdig nakomt dan wel geheel of gedeeltelijk niet nakomt te allen tijde met kennisgeving per aangetekende post en zonder voorgaande ingebrekestelling het contract van rechtswege geheel of gedeeltelijk als onbestaande beschouwen. In dit geval moet de klant onverwijld en uiterlijk binnen de 48 uur na ontvangst van de kennisgeving de identificeerbare (niet geïncorporeerde) goederen ter onze beschikking stellen. De niet betaling op de vervaldag van een factuur maakt het verschuldigd saldo van alle andere facturen van rechtswege onmiddellijk opeisbaar, onafgezien van de bij voorbaat toegestane betalingsvoorwaarden.

## EIGENDOMSRECHT

Onverminderd het risico van de klant met betrekking tot de goederen behouden wij ons eigendomsvoorbehoud op de geleverde goederen voor tot volledige betaling van de prijs. De klant wordt bij het tot stand komen van de overeenkomst en voor de levering van de goederen uitdrukkelijk gewezen op dit eigendomsvoorbehoud en wordt behoudens schriftelijk protest, uiterlijk op het moment van de levering, veronderstelt hiermee in te stemmen. Wij behouden ons tevens het recht voor om mits voorafgaandelijke schriftelijke ingebrekestelling een retentierecht uit te oefenen op de goederen van de klant in ons bezit tot zekerheidsstelling van alle openstaande vorderingen. Bij levering van goederen gaat het risico voor verlies, tenzij anders bepaald, over van zodra de klant verwittigd wordt dat de goederen op onze zetel beschikbaar zijn. Wanneer de goederen verder bij ons bewaard worden, of, op vraag van de klant vervoerd worden, gebeurt dit voor rekening en op risico van de klant. Wij alsmede de klant verklaren uitdrukkelijk dat alle schuldvorderingen van welke aard dan ook, huidige en toekomstige, waarover zij jegens elkaar beschikken, tussen hen onderling automatisch gecompenseerd worden met alle schulden van welke aard ook, huidige en toekomstige, die zij jegens elkaar verschuldigd zijn en dit op het ogenblik van het ontstaan van de respectieve schuldvorderingen en schulden, onafhankelijk van hun opeisbaarheid. In geval van faillissement of ontbinding van de klant of indien de klant het minnelijk akkoord of de gerechtelijke reorganisatie aanvraagt conform de wet van 31.01.2009 op de continuïteit der ondernemingen, zullen wij het recht hebben om de op het ogenblik van de faillietverklaring, ontbinding of aanvraag van één van de procedures van de wet van 31.01.2009 door de klant, ten laste van deze laatste nog bestaande, al dan niet opeisbare schuldvorderingen van welke aard dan ook, te compenseren met de ten voordele van ons op datzelfde ogenblik nog bestaande schulden, vooraleer één of andere storting aan de gezamenlijke schuldeisers van de gefailleerde, ontbonden of de zich op de wet van 31.01.2009 beroepende klant te doen.

## GARANTIE

Wij verlenen, behoudens andersluidende overeenkomst in meer of in min, maximaal 2 jaar garantie op onze producten. De garantie start op de dag dat het product door een officiële handelspartner van JARDINICO Parasols is aangekocht (facturatedatum). De garantie is van toepassing op productie- en/of materiaalfouten, veroorzaakt ten gevolge van een normaal gebruik. Het product zal niet geheel vervangen worden als een defect onderdeel en/of component vervangen kan worden. JARDINICO Parasols zal geenszins tot garantie gehouden zijn wanneer de gebreken het gevolg zijn van een oneigenlijk of verkeerd gebruik door de eindgebruiker.

## UITZONDERINGEN VAN DE GARANTIE

De garantie is enkel van toepassing op productie- en/of materiaalfouten, veroorzaakt ten gevolge van een normaal gebruik. Het product zal niet vervangen worden als een defect onderdeel en/of component vervangen kan worden. Deze garantie dekt geen defecten veroorzaakt door onjuiste montage, defecten als gevolg van wijzigingen door de koper, opzettelijke schade, verkeerd gebruik, misbruik of nalatigheid, het niet aankopen van een bijpassende voet of grondanker en normale slijtage als gevolg van leeftijd en arbeid of montagekosten. Het vervangen van onderdelen zal uitgevoerd worden door de eindgebruiker of de detailhandelaar. Jardinico PARASOLS beperkt zich in dergelijk geval enkel tot het ter beschikking stellen van de te vervangen onderdelen en/of componenten van deze eindgebruiker of de detailhandelaar. Ons bedrijf behoudt zich het recht voor om op elk moment en zonder voorafgaande kennisgeving een Frame te schrappen uit de collectie. Al onze reserveonderdelen blijven in stock tot 2 jaar nadat het product werd stopgezet. Wanneer de koper vaststelt niet over een gebruiksaanwijzing of een voor hem/haar onduidelijke gebruiksaanwijzing te beschikken, moet dit onmiddellijk gemeld worden bij aankoop. Indien de koper is overgegaan tot installatie van het gekochte product, zonder deze voorafgaande melding, vervalt alle garantie. Artikelen aangekocht in uitvoerke voor einde collectie worden nooit vervangen of terugbetaald. Parasolribben vallen buiten de huidige garantie.

## SCHADE DOOR WIND VALT NIET ONDER ONZE BEPERKTE GARANTIE.

Natuurrampen (inclusief maar niet beperkt tot wind, orkanen, tornado's en stormen) en natuurlijke aspecten van het verouderingsproces vallen niet onder deze garantie en worden daarom niet als een defect beschouwd. Geen enkele parasol, ongeacht de grootte of het gewicht, mag onbeheerd worden achtergelaten in open positie. Bij minderige omstandigheden wordt aanbevolen om parasols te sluiten, van hun voet te verwijderen en op te bergen of horizontaal neer te leggen. Dit zal de kans op schade aan uw parasol en andere bezittingen of eigendommen verminderen. De garantie dekt geen verkleuring, het uitlopen van kleuren, veranderingen in texturen, krassen, barsten of schade in lak, ontstaan door gebruik en/of gebrekking onderhoud/verkeerd gebruik. Deze opsomming is niet-limitatief. Na verloop van tijd wordt natuurlijk teak grijs. Het oppervlak kan verkleuring vertonen. Er zijn passende behandelingen beschikbaar om ervoor te zorgen dat de parasols hun oorspronkelijke uiterlijk behouden. Laat geen vuil opstapelen op de voet. Het wordt aanbevolen om te reinigen met milde zeep en water. Laat de voet van de parasol nooit in water staan. Bij gebruik aan het strand of een binnenzwembad kunnen zout & chloor zich gaan opstapelen op de powder coating en de afwerking aantasten. Om ervoor te zorgen dat de voet er op zijn best blijft uitzien, kan u ze best opbergen wanneer hij voor langere tijd niet wordt gebruikt. De koper erkent uitdrukkelijk op de hoogte te zijn van bovenstaande zaken en erkent eveneens dat deze niet beschouwd kunnen worden als een gebrek aan overeenstemming in de zin van artikel 1649ter BW. De koper erkent daarnaast uitdrukkelijk in kennis te zijn gesteld dat bij de bewerking van stoffen en metalen kleurverschillen kunnen bestaan. De louterende vaststellingen van dergelijke kleurverschillen zal nooit aanleiding kunnen zijn tot weigering van enige levering, tenzij het tegendeel schriftelijk en op voorhand bedongen werd.

## BEVOEGDE RECHTBANK

Voor alle geschillen zijn alleen de Rechtbanken van het arrondissement Kortrijk bevoegd en is het Belgisch recht van toepassing. Enkel Jardinico PARASOLS kan hiervan afwijken.



jardinico<sup>®</sup>

Evolis 101  
8530 Harelbeke  
Belgium  
+32 (0)56 89 04 10

[info@jardinico.com](mailto:info@jardinico.com)  
[www.jardinico.com](http://www.jardinico.com)

